

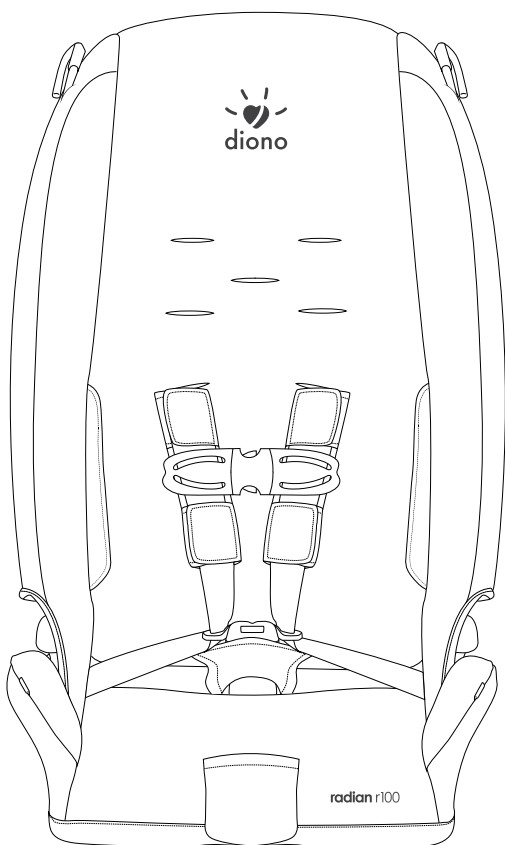

Rear-facing:
5-40 pounds (2.3-18 kg)
Forward-facing:
20-65 pounds (9-29.5 kg)
Booster mode:
50-100 pounds (23-45 kg)

radian[®] r100

all-in-one convertible



Instruction Manual

US English

Please read carefully
Store manual behind cover



Table of Contents

Before You Start

First Steps Summary	4-6
Registration	4
Get to Know Your Car Seat	5
Seat Position	5
Harness Position	5
Installation	6
Rear-facing Installation	30-37
Forward-facing Installation	38-48
Booster Mode Installation	49-50
Unfolding and Folding the Car Seat	7-9
LATCH vs. Seat Belt Installation	10-11

Safety

Get to Know the Parts and Features of your diono® radian r100	12-13
Warnings	14-15
Child Car Seat Safety Information	16-17
Vehicle Seat Belt Systems	18-19
Locking a Vehicle Lap-Shoulder Belt with a Locking Clip	20
Car Seat Stability Checklist	21

Properly Securing Your Child

Position of the Harness (Rear-facing or Forward-facing	22-23
Lap Belt Cushion Use	24
Securing the Harness Straps, Harness Buckle, and Harness Pads	25-28
Expandable Sides	29

Rear-Facing Installation

Installing and Removing Detachable Base	30
Rear-facing SuperLATCH™ Installation	31-33
Rear-facing Lap-Shoulder Belt Installation	33-34
Rear-facing Lap Belt Installation	35-36
Rear-facing Top Tether Installation	37

Forward-Facing Installation

Safe Stop® Instructions	38
Forward-facing Adjustable Bottom.....	39
Forward-facing SuperLATCH™ Installation	40-42
Forward-facing Lap-Shoulder Belt Installation.....	43-44
Forward-facing Lap Belt Installation	45-47
Forward-facing Top Tether Installation.....	48

Booster Mode Installation

Booster Mode Installation	49-50
---------------------------------	--------------

Final Checklist

Final Checklist for All Installations.....	51
--	-----------

Additional Information

Carrying the Car Seat.....	52
Cup Holder (not included).....	53
Car Seat Cover (Removing and Replacing)	54
Cleaning and Maintenance	55-57
Replacing Harness Straps	58
Aircraft Installation.....	59
Warranty Information	60

WARNING:

- Failure to follow **ALL INFORMATION PROVIDED** on the labels and in the instruction manual can result in serious injury or death to your child.

First Steps Summary

Registration

Register your car seat.

- Mail in your registration card or go online to **us.diono.com/product-registration** and register your car seat.

REGISTER your car seat online at **us.diono.com/product-registration** or PLEASE COMPLETE AND MAIL THE OWNER REGISTRATION CARD THAT CAME WITH YOUR SEAT WITHIN THIRTY (30) DAYS OF PURCHASE. Any claim or legal action available to the purchaser under this Limited Warranty must be filed or brought within one year from the date of original retail purchase, and purchaser agrees that in the event of any dispute, all disputes shall be brought, if at all, in a court located in Pierce County, Washington to the exclusion of any other court. The prevailing party shall receive all costs and reasonable attorneys' fees, including for any appeal.

Consumer: Please fill out your name, address, and email address (optional).

Your Name _____

Your Street Address _____

City _____ State _____ ZIP Code _____

Email Address (optional) _____

CHILD RESTRAINT REGISTRATION CARD

US 06302017

Child restraints could be recalled for safety reasons. You must register this restraint to be reached in a recall. Send your name, address, email address if available, and the restraint's model number and manufacturing date to **Diono LLC, PO Box 77129, Seattle, WA 98177**, or call **1-855-463-4666**, or register online at **us.diono.com/product-registration/**.

For recall information, call the U.S. Government's Vehicle Safety Hotline at **1-888-327-4236** (TTY 1-800-424-9153), or go to **http://www.NHTSA.gov**.

Get to Know Your Car Seat

Read all safety warnings on pages 14-15.

Upon removing your car seat from the box, unfold your seat.

(See pages 7-9)

- Check to be sure the area is clear of debris.
- Remove body support and infant head support cushions.
- Check that your seat is in the unfolded and locked position.

Get to know the parts, pieces, and accessories of your car seat.

(See pages 12-13)

Seat Position

Determine the seating position of your child.

(See pages 10-11)

- Will your child be rear-facing or forward-facing?

Determine how you will be installing your seat.

(See pages 10-11)

- LATCH or seat belt installation.
- Top Tether.
- Booster Mode without harness.
- Safe Stop® (**Please Note:** Do not discard Safe Stop® as you may need this piece later during your child's development.)

Harness Position

Be familiar with the steps to properly secure your child in your car seat.

(See pages 22-29)

- Proper harness height and maximum child weights.
- Harness buckle location and installation.
- Lap belt cushion.

First Steps Summary (cont.)

Installation

Properly secure your car seat in your car.

(See pages 30-37 for rear-facing installation and pages 38-48 for forward-facing installation)

- Double check your work.
- Did you do a car seat stability check?

Place your child in your installed car seat.

(See pages 22-29)

- Are your harness straps snug?
- Is your child's harness in the correct position?
- Double check your work.

Important: It is important to check your car seat in ALL installation methods right away. Do not wait. Doing so ensures your seat works when installed with a seat belt, SuperLATCH™ and in booster mode.

Unfolding and Folding the Car Seat

⚠️ WARNING!

DEATH or SERIOUS INJURY can occur,

- Do **NOT** carry the car seat by harness adjuster strap. This can damage the mechanism and the webbing.
- Do **NOT** use the car seat if release levers or locking bolts bind or do not move freely. When release levers are lifted, release levers and locking bolts should spring back immediately.
- Do **NOT** oil or lubricate any part of car seat.
- **ALWAYS** confirm car seat is locked securely in its unfolded position before each use.
- To avoid risk of injury, keep others at a safe distance during folding and unfolding.
- Familiarize yourself with car seat unfolding and folding operations prior to use.
- Foreign objects and debris can interfere with proper operation of locking mechanism. Before installation, confirm both locking bolt and release lever areas are free of any debris (*See pages 55-57 for cleaning of mechanisms*).

Unfolding the Car Seat

Important: Before unfolding seat, remove body support cushion, if it is present.

1. Place car seat on its back on a flat surface and unfasten red carry strap from the bottom. Be sure the harness adjuster moves freely and is not locked within the bottom of the seat.

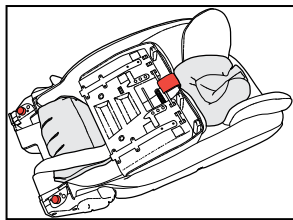

2. Firmly rotate the bottom until a 'click' confirms the car seat is locked in the open position.

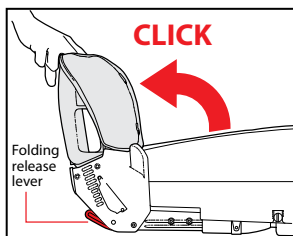

Unfolding and Folding the Car Seat (cont.)

3. Pull harness adjusting strap until harness begins to tighten. If strap does not slide freely, fold car seat, remove harness adjusting strap from fold joint and repeat Step 3.

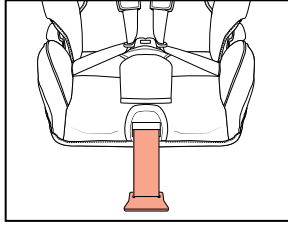

4. Fasten both fabric side panels to center panel.

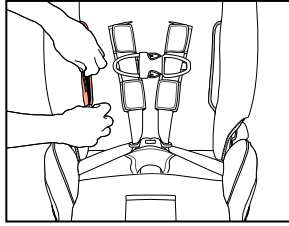

5. **To Store:** Tuck the red strap behind cover through the slit in the cover between the top two harness slots.

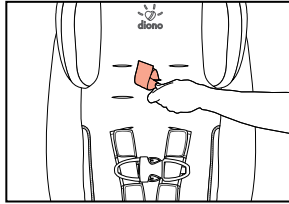

Important: Confirm release levers are completely recessed inside their housings. Confirm the car seat is locked in the open position. If not, repeat Step 2.

Folding the Car Seat

1. Unbuckle harness and remove the infant cushions (if used) and take out the red carry strap from behind the cover. Unfasten both fabric side panels and open fully.

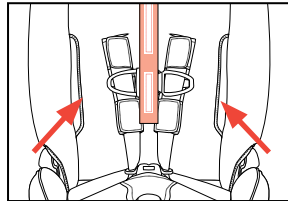

2. Loosen harness straps, pads, and chest clip: lift silver harness adjuster while pulling the harness straps all the way forward towards the top center of the car seat.

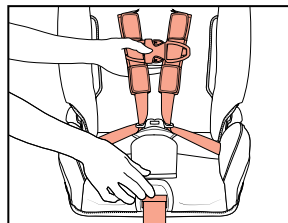

Unfolding and Folding the Car Seat (cont.)

3. Adjust both expandable sides to their inward position.
4. Place car seat on its back, push either release lever downward to release locking bolts.

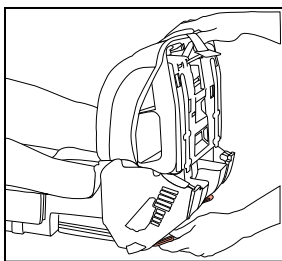

5. Keep harness buckle lifted toward the top of the car seat while folding seat bottom up to avoid pinching the buckle within the fold.

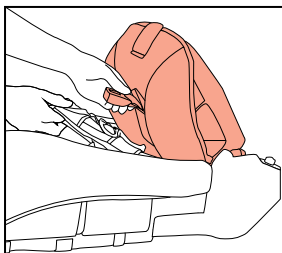

6. Fasten red carry strap on the first metal bar to secure the bottom of the car seat in its folded position.

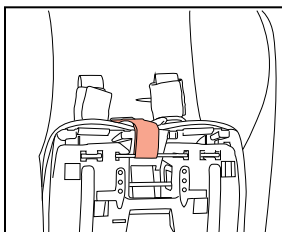

Important: If car seat does not easily fold completely, **DO NOT** force it closed. Repeat steps 1-6 as needed.

WARNING:

- Car seat can accidentally unfold and cause injury if not properly secured by carry strap.

LATCH vs. Seat Belt Installation

WARNING:

- This car seat should **NEVER** be installed using both the lower anchors and the seat belt at the same time.

Either installation meets all Federal Motor Vehicle Safety Standards. In some vehicles one or the other might give you a correct installation. In many cases, either one will give you a correct installation.

LATCH stands for Lower Anchors and Tethers for Children. SuperLATCH™ is the same as LATCH, but only attaches to the lower anchors of your vehicle's seats.

Here are your choices for installation: Diono always recommends using the Top Tether strap if an appropriate anchor is available.

Rear-Facing Capacity

Child's Weight: 5-40 pounds
Child's Height:
Less than 1.5 inches from top
of head to top of seat

- | | |
|---|-----------------|
| • SuperLATCH™ only | up to 35 pounds |
| • SuperLATCH™ & top tether | up to 35 pounds |
| • Seat belt only | up to 40 pounds |
| • Seat belt & top tether | up to 40 pounds |
| • Lap-shoulder belt over child | |
| • Lap-shoulder belt over child
with SuperLATCH™ & top tether | |

Expiration Date

All car seats have expiration dates.

The radian® r100 car seat expires 10 years after the date of purchase (DOP). If the date of purchase can't be determined, refer to the date of manufacture (DOM).

Not all car seats can install correctly in different modes in the same car. Try installing the car seat in all configurations; rear-facing, forward-facing and booster mode. Utilize each way you can install this car seat so you are aware of proper fit for future use in the same vehicle.

LATCH vs. Seat Belt Installation

Got a Question?

Please visit our website us.diono.com for tips and videos on installations, adjusting the harness and other frequently asked questions.

Or, you can call our Customer Care Department. We have highly trained Customer Care Representatives who are also Certified Child Passenger Safety Technicians (CPST).

Call us Toll-Free at 1-855-463-4666. We are open from 7 a.m. – 5 p.m. Pacific Standard Time, Monday through Friday.

In addition, a certified Child Passenger Safety Technician might be located near you. To find one you can go to,

http://safekids.org/events/field-type/check_event.

These individuals are usually volunteers, dedicated to educating parents on installations and are willing to help.

Please note: These technicians are **NOT** employed by Diono, LLC.

Forward-Facing Capacity

Child's Weight: 20-65 pounds

Child's Height:

Up to 57 inches tall or top of ears are above top of seat

up to 40 pounds

up to 40 pounds

up to 65 pounds

up to 65 pounds

Booster Mode

Child's Weight: 50-100 pounds

Child's Height:

Up to 57 inches or top of ears are above top of seat

up to 100 pounds

up to 100 pounds

WRITE YOUR SEAT INFORMATION HERE:

MODEL #: _____

DOP: _____ / _____

DOM: _____ / _____

SERIAL #: _____



Get to Know the Parts and Features of your diono radian[®] r100

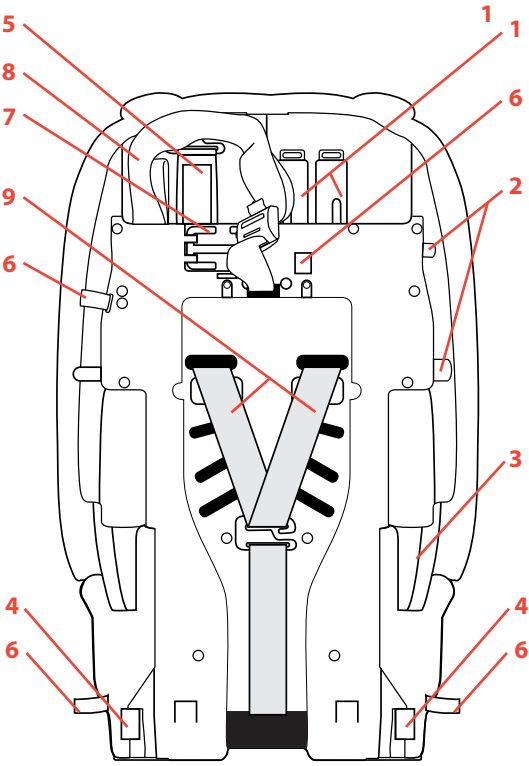

- | | |
|---|--|
| 1 SuperLATCH™ storage | 14 Rear-facing belt path |
| 2 SuperLATCH™ attachment strap guide | 15 Booster mode shoulder belt guide |
| 3 Forward-facing belt path | 16 Buckle pad |
| 4 Folding release levers | 17 Detachable rear-facing base |
| 5 Safe Stop® | 18 Rear-facing top tether connector strap |
| 6 Carry strap loops | 19 Lap belt cushion |
| 7 Locking clip | |
| 8 Top tether strap | |
| 9 Harness straps | |
| 10 Chest clip | |
| 11 Buckle | |
| 12 Expandable sides | |
| 13 Harness adjuster strap | |

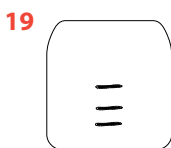
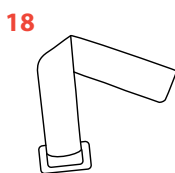
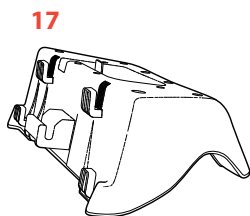
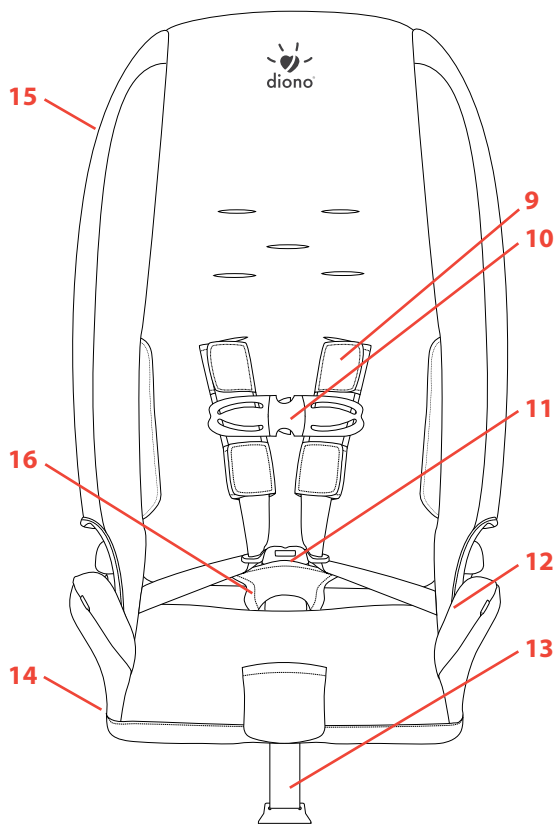

⚠️ WARNING!**DEATH or SERIOUS INJURY can occur,**

- Use only in a rear-facing position when using it with an infant weighing less than 20 pounds (9.1kg).
- Use **ONLY** with children who weigh between 5 and 100 pounds (2.3 and 45 kg) and whose height is 57 inches (144 cm) or less.
- Snugly adjust the belts provided with this child restraint around your child.
- Secure the top anchorage strap provided with this child restraint.
- Warning! Use **ONLY** the vehicle's lap and shoulder belt system when restraining the child in this booster seat.
- Secure this child restraint with the vehicle's child restraint anchorage system if available or with a vehicle belt.
- Follow all instructions on this child restraint and in the written instructions located on the back of the car seat.
- Register your child restraint with the manufacturer.
- Follow all instructions labeled on this child car seat and in the written instruction manual on the lanyard located on back of car seat. For newborns or children without head control, consult pediatrician for recommended seat back angle before installation.
- Failure to follow all instructions and product labels can result in death or serious injury in a crash. Carefully read and understand this instruction manual prior to using car seat. If you have any questions, visit **us.diono.com** or contact Diono at **1-855-463-4666**.
- **Child weight limits:**

Rear-facing:	5-40 pounds (2.3-18 kg)
Forward-facing with 5-point harness:	20-65 pounds (9-29.5 kg)
Booster mode:	50-100 pounds (23-45 kg)
- **Child maximum heights:**

Rear-facing:	44 inches (112 cm)
Forward-facing:	57 inches (144 cm)
- **ALWAYS** use the Safe Stop® device according to manufacturer's instructions.
- **ALWAYS** use a locking clip if it is required for proper car seat installation. Consult vehicle owner's manual.
- **ALWAYS** adjust restraint harness for a comfortable and snug fit around child. A snug harness strap should not allow any slack. It lies in a relatively straight line without sagging. It does not press on the child's flesh or push the child's body into an unnatural position.
- This car seat is **NOT** for use in homes, boats, on a motorcycle or in any other non-specified applications or environments.

⚠️ WARNING!**DEATH or SERIOUS INJURY can occur,**

- Add-on child restraint systems should be securely belted to the vehicle, even when they are not occupied, since in a crash an unsecured child restraint system may injure other occupants.
- In the event of an accident, the vehicle body itself provides the most significant passenger protection. While a properly installed car seat will improve chances for survival in most accidents, some crashes are unsurvivable regardless of what car seat is used.
- According to accident statistics, in vehicles with rear seating positions children are safer when properly restrained in the rear seating positions than in the front seating positions.

Child Seating Position Information**⚠️ WARNING:**

- Owners of vehicles with front passenger side air bags should refer to their vehicle owner's manual for child restraint installation instructions
- This child restraint system must be used **ONLY** in a forward-facing seating position equipped with a vehicle seat belt or **LATCH** anchors. Some vehicles have no seating positions which are compatible with this child seat. If in doubt, contact the vehicle manufacturer for assistance.

Forward-facing vehicle seats **MUST** be used with this child seat. Side-facing or rear-facing seats **CANNOT** be used.

This car seat meets all applicable Federal Motor Vehicle Safety Standards. This restraint is certified for use in passenger cars, multipurpose passenger vehicles, and trucks.

⚠️ WARNING!**DEATH or SERIOUS INJURY can occur:**

Only use this child restraint in forward-facing vehicle seats. **DO NOT** use this child restraint in side-facing or rear-facing seats.



Seats which face sides of vehicle.

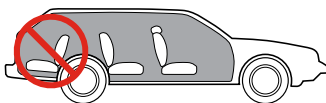

Seats which face rear of vehicle.

Child Car Seat Safety Information

WARNING:



DO NOT use rear-facing child restraints at seating positions equipped with air bags. Air bags inflate rapidly and may impact the restraint with enough force to crack the shell and cause death or serious injury.

According to accident statistics, children 12 and under are safer when properly restrained in rear vehicle seating positions than in front vehicle seating positions.

Important:

- Before each use, always confirm car seat is securely installed and harness is properly adjusted around the child. Remember: The addition or removal of clothing will change the fit of the harness, especially bulky winter jackets. Diono recommends harnessing your child first and placing a blanket over them or putting their jacket on backwards.
- **ALWAYS** confirm before each use that car seat is securely locked in its unfolded position.
- If the vehicle seat has an adjustable seat back angle, make sure seat back is securely locked open in its most upright position. An incorrect seat back angle or unsecured seat back will impair the car seat installation and its ability to protect the child occupant.
- Cover car seat when vehicle is parked in direct sunlight. Parts of the car seat can become hot and cause injury to a child.
- **DO NOT** leave any child in a vehicle alone or unattended by an adult.
- Add-on child restraint systems should be securely belted to the vehicle, even when they are not occupied, since in a crash an unsecured child restraint system may injure other occupants."

Child Car Seat Safety Information

Important:

- Secure all personal objects inside the vehicle. In an accident, loose objects can become flying hazards with the potential for causing serious injury.
- Except per the instructions in this manual or as instructed by a representative of the manufacturer, do not disassemble, attempt to disassemble or tamper with any part of this car seat or change the way the car seat harness or the vehicle restraint system is used. Doing so will void the warranty.
- **DO NOT** use car seat if there is any appearance of rust on any of the metal surfaces.
- **DO NOT** oil or lubricate any part of the car seat.
- Release levers and locking bolts should operate smoothly and freely. When release levers are lifted, the release levers and locking bolts should spring back immediately and completely. **DO NOT** use car seat if release levers and/or locking bolts wither, bind or do not move freely.
- When not in use, store car seat in a climate-controlled area, and avoid placing heavy objects on top of it.

To prevent injury to child:

- **DO NOT use this car seat if it is older than 10 years from the original date of purchase.** If the original date of purchase cannot be determined, **DO NOT** use this car seat if it is older than 10 years from the date of manufacture. The date of manufacture can be found on the information label permanently affixed to the car seat.
- If the webbing of the harness system becomes soiled and cannot be cleaned per the instructions in this manual, the harness system **MUST** be replaced. Replacement of the harness system does **NOT** extend the life of this car seat beyond 10 years.
- **DO NOT** use car seat after it has been involved in any crash, whether the child was present in the car seat or if the car seat was unoccupied. Damage to the car seat may have occurred which could impair its ability to adequately protect a child. Please call our Customer Care team at **1-855-463-4666** so we can help you determine if your seat needs to be replaced.
- This car seat is not a toy. Do not allow children to play with it.
- Using any non-Diono product with this car seat, or any product not specifically approved by Diono for use with this car seat, is not allowed. Use of such products voids manufacturer's warranty and may seriously impact this product's ability to perform properly in a crash.

Vehicle Seat Belt Systems

⚠ WARNING:

- Check your vehicle owner's manual for information about car seat compatible seat belts, seating positions, and LATCH positions.
- **NEVER** use this seat with a seat belt or seating position where it cannot be installed and adjusted according to the instructions for that mode.
- **NEVER** use this seat with any vehicle seat belt system listed in the "Unsafe Vehicle Belt Systems" section (See page 19).

The information below applies only to installation using vehicle seat belt.

Important:

- NEVER use this car seat in Booster Mode with a lap belt only.
- Some vehicles do not have any seating positions that are compatible with a car seat. Read vehicle owner's manual to determine seating position and vehicle belt car seat compatibility. Contact the vehicle manufacturer if you have any doubts or questions.
- This child restraint can be installed securely in most vehicles using the seat belt. The following information identifies the vehicle belts that this child restraint can and cannot be used with.

SAFE vehicle seat belt systems:

Lap/shoulder belts with locking latch plate.

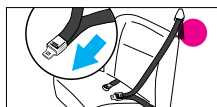

Lap/shoulder belt with sliding latch plate. Most lap/shoulder belts with sliding latch plates can be switched into locking mode by fully extending the belt, after which the belt can retract, but will not extend. Check your vehicle owners manual for more information about your specific vehicle. If your vehicle belt cannot be switched to locking mode and you cannot achieve a secure installation, you may need a locking clip: please contact our Customer Care department at 1-855-463-4666 for more information.



Manually adjustable lap belts.

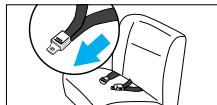

Vehicle Seat Belt Systems (cont.)

Lap belts with switchable retractors or Automatic Locking Retractors (ALR).

- Switchable retractors can be switched from non-locking to locking mode. Most switchable retractors are switched by fully extending the belt, after which the belt can retract, but will not extend.
- ALRs allow the belt to be pulled out freely until it is allowed to begin to pull back in, after which the belt will not extend.

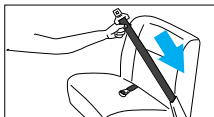

Belts with anchor points forward of the seat crease may or may not allow for secure installation. Check for movement of the seat after tightening.

Important: DO NOT use this type of vehicle belt if a secure installation cannot be achieved.

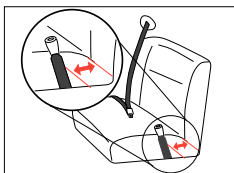

UNSAFE vehicle seat belt systems:

DO NOT use the following types of seat belt systems with the car seat. Install the car seat with the LATCH system or in another vehicle seating position equipped with a safe vehicle seat belt system.

Lap and shoulder belts with anchorage points attached to the vehicle door.

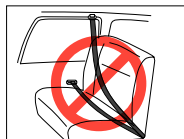

Motorized lap/shoulder belts.



Non-locking lap belts with Emergency Locking Retractor (ELR).



If your seat belt is one of the types listed above, choose another seat within the vehicle or use LATCH connectors and anchorage points. Information on the types of seat belts in your vehicle are in the vehicle owner's manual. See Lower Anchor weight limits for each mode of installation (*See pages 31 and 40*).

Inflatable Seat Belt:

Currently this car seat is compatible with only Ford Motor Company's Inflatable Seat Belts for all installation modes and booster mode. Consult your vehicle owner's manual for more information.

Locking a Vehicle Lap-Shoulder Belt with a Locking Clip

WARNING:

- Failure to properly lock the seat belt will result in an unsafe installation that will greatly increase the potential for injury or death to the child in an accident.
- If your vehicle lap shoulder seat belt is equipped with ELR (Emergency Locking Retractor) that does not switch to function as an ALR (Automatic Locking Retractor), you **MUST** use a locking clip to secure lap portion of vehicle seat belt. If you have any questions about the specific type of seat belt system in your vehicle and its operation, consult your vehicle owner's manual or contact vehicle manufacturer.

For rear-facing (*See pages 35-36*) and forward-facing (*See pages 45-47*) on a lap-shoulder belt installation.

1. Remove locking clip from storage location on the upper left side car seat back.
2. After seat belt is tightened, hold the lap and shoulder portions together with one hand. This determines the correct seat belt length.
3. Using your other hand, press and release the seat belt buckle. While still holding the lap and shoulder belts together, slide the belts into the locking clip.
4. Re-insert seat belt buckle tongue into buckle and check for a tight fit at the correct belt path for chosen installation.
5. If seat belt is not tight enough, re-tighten seat belt and repeat Steps 2 through 4.
6. Once seat belt is tight and locked, follow instructions for Top Tether Use (*See page 37 for rear-facing or page 48 for forward-facing*), if applicable.

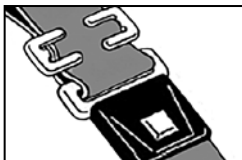
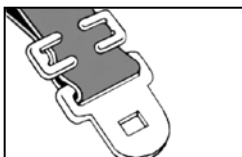

Tip: To prevent loss after use, secure locking clip in its storage location on the back of the car seat.

Car Seat Stability Checklist

WARNING:

- An unstable installation is **NOT** safe and will greatly increase the potential for injury or death to the child in an accident.

Confirm stability of car seat after installation and before each use. Here's how to check:

1. Grasp car seat near belt path being used. Attempt to move car seat side-to-side and front-to-back: car seat should not move more than 1 inch in any direction. Car seat should stay securely installed and the securing belt (either LATCH belt or vehicle seat belt) must remain tightly adjusted.
2. If car seat does not stay securely installed, car seat installation is **NOT** safe. You **MUST** re-install car seat according to the car seat instructions and your vehicle owner's manual. In order to achieve proper installation you may need to choose an alternate installation method or seating location within the vehicle.

Check for correct belt path use.

Read belt path label.

**Seat belt installed?
Is seat belt in locking mode?**

Lower anchor strap installed?

Be sure the strap is tight and not slipping loose.

Do not grab top of seat for stability check.

Attach top tether if appropriate anchor is available.

Is the seating position appropriate for a car seat installation?

Check vehicle manual.

Positioning of the Harness (Rear-facing or Forward-facing)

WARNING:

- Serious injury or death can result if child is not properly secured in car seat. Confirm harness is snug before each use and after making any car seat adjustments. *A snug restraint strap should not allow any slack. It lies in a relatively straight line without sagging. It does not press on the child's flesh or push the child's body into an unnatural position.*

1. Confirm proper car seat installation.
2. To loosen harness: lift silver harness adjuster and pull shoulder straps forward.
3. Unfasten chest clip and buckle, and move harness straps to the sides.
4. Properly position child in car seat: sitting upright and all the way back in the car seat.

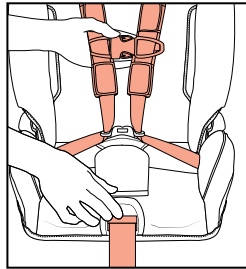

5. Position harness straps around child and fasten buckle with circle buckle pad between buckle and child.
6. Confirm harness buckle is properly fastened by gently tugging.
7. Gently pull harness straps upward to snugly fit lap portion of harness which should fit low on child's body, across the hips.

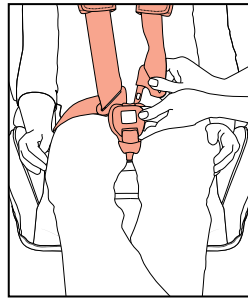

8. Slowly pull harness adjuster strap downward (forward-facing) or straight up (rear-facing), using a pull-tug, pull-tug motion, to tighten harness for a comfortable and snug fit around child.

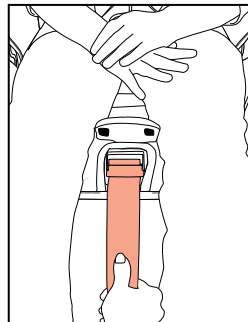

Positioning of the Harness (Rear-facing or Forward-facing)(cont.)

9. Confirm harness is not twisted and lays flat against child.
10. Properly position chest clip so that it is level with child's armpits. Fasten chest clip together.

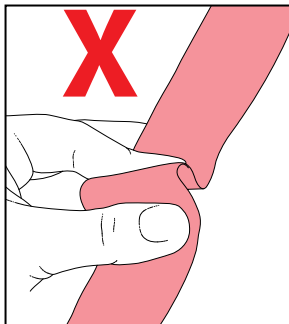
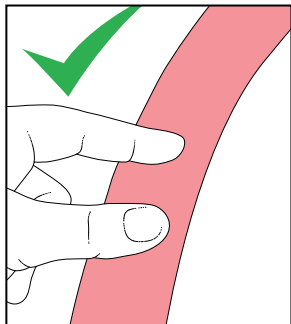
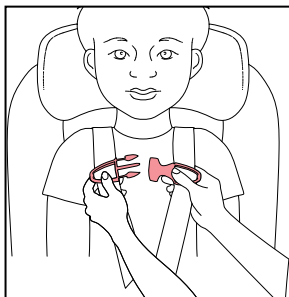

Do the Pinch Test

Take the thumb and index finger and 'glide' your fingers along the harness at the collarbone, not necessarily trying to pinch excess. If you are able to pinch more than half an inch of the harness strap, the straps should be tightened down more. If you are getting less than half an inch the harness is secured properly.

Lap Belt Cushion Use

Use the lap belt cushion in forward-facing lap belt installation only and no top tether for children 20-65 pounds (9-29.5 kg).

1. Remove the buckle pad by pulling it up and off the buckle.

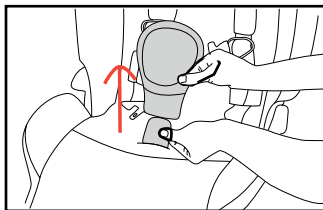

2. Slide metal buckle through the slot in the lap belt cushion that matches the slot position used on the seat bottom.

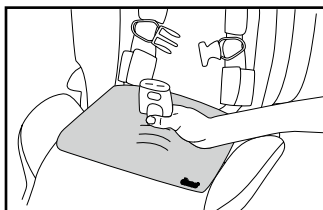

Securing the Harness Straps, Buckle, and Harness Pads

⚠️ WARNING:

- All harness slot positions can be used rear-facing, however, only use the top three shoulder harness positions for forward-facing.



For step-by-step installation videos, please visit: www.youtube.com/DionoUSA

Max Child Height

Adjust to correct harness height before installing the car seat:

- 1. Rear-facing:** Straps should be in nearest slot at or below the level of child's shoulders.

Maximum Height: Rear-facing child is too tall for car seat if top of head is less than 1½ inches from top of car seat or if child is more than 44 inches tall (112 cm).



- 2. Forward-facing:** Straps should be in slot above the level of child's shoulders.



- 3. Maximum Height:** Forward-facing child is too tall for car seat if tops of the ears are above the back of the car seat or if child is more than 57 inches tall (144 cm).

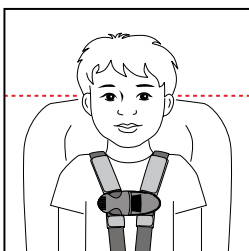

Securing the Harness Straps, Buckle, and Harness Pads (cont.)

Changing Harness Position

1. Loosen harness: lift silver harness adjuster and pull shoulder straps forward.

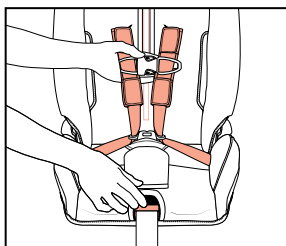

2. From back of car seat, remove shoulder straps from metal hook.

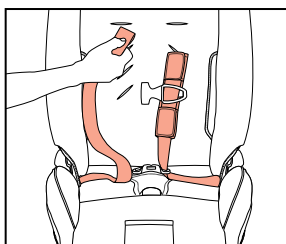

3. From front of car seat, pull shoulder straps out and re-thread them through the correct height harness slots.

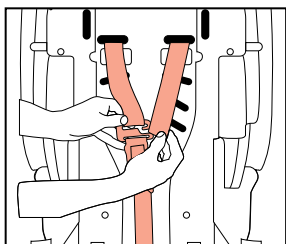

4. From back of car seat, reattach shoulder straps to metal hook (left strap first).

5. Confirm harness straps are not twisted and both shoulder straps are threaded through car seat at the same height.

Important: Make sure loop ends of **BOTH** straps are threaded completely onto the arm of the metal hook. Attach left harness first then right harness, while looking at the back of the car seat.

Securing the Harness Straps, Buckle, and Harness Pads (cont.)

Proper Buckle Position

1. Confirm location of buckle is correct.

To ensure proper harness fit:

Place child in the car seat to determine proper harness buckle position.

- For rear-facing, any of the 3 buckle positions are acceptable, as long as the harness is snug on the child's shoulders.
- For forward-facing, see Step 2 below.

2. **For children 5–30 pounds:** Buckle can be directly above its buckle slot (Fig. A) or forward of its buckle slot (*See Figure B*).

For forward-facing children over 30 pounds: Always use forward-most buckle location.

In all cases, be sure the buckle is up against the child's body.

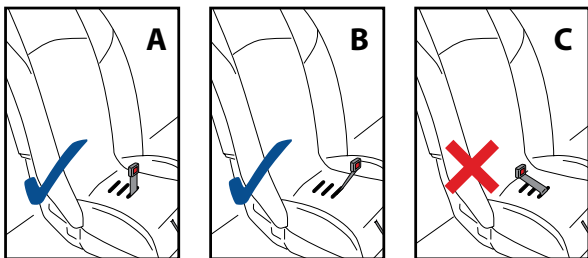

Change Buckle Position

Tip: If you remove the bottom portion of the cover, the harness buckle will be easier to adjust.

1. Locate correct buckle slot.
2. Unbuckle harness.
3. Push harness buckle strap down 2 inches into rear facing belt path tunnel.
4. Guide buckle strap and metal D-ring upward and rotate it slightly to fit through the rear-facing belt path in the car seat bottom.

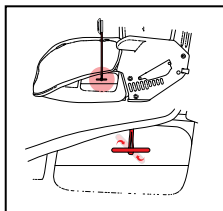

Securing the Harness Straps, Buckle, and Harness Pads (cont.)

5. Hold metal D-ring and then rotate it slightly to slide it completely through desired slot in car seat bottom.
6. Firmly pull buckle upward to confirm it is secured by car seat bottom.
7. Confirm red release button faces toward front of car seat and buckle strap is not twisted.
8. For larger hands or if buckle is in position closest to child, partially fold the car seat to access metal D-ring through bottom of car seat.

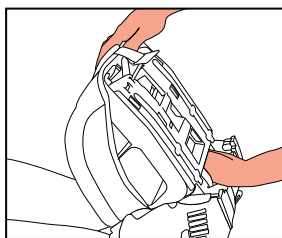
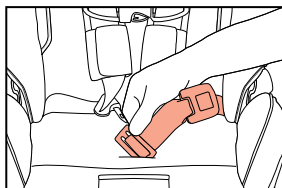

Harness Pads

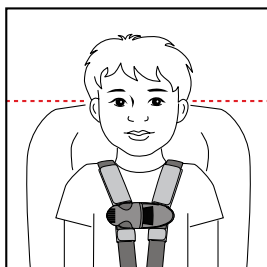

Important:

- Always utilize the soft harness pads when forward-facing. Usage for rear-facing is optional.

Expandable Sides

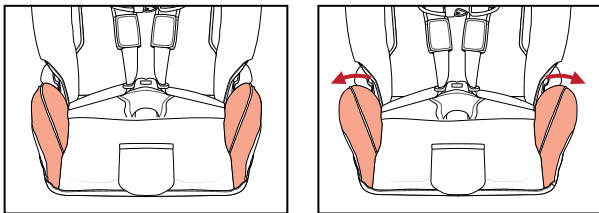

Expanding the sides of the car seat is optional and does not compromise the safety of the seat.

Sides may be adjusted either inward or outward.

Important: Before folding the car seat, both sides must be adjusted to their inward position (*See pages 7-9 for folding car seat*).

Installing and Removing Detachable Base

⚠ WARNING:

- Detachable base **MUST** be used only when the car seat is rear-facing.
- **DO NOT** use detachable base when the car seat is forward-facing.
- **DO NOT** use pool noodles or rolled towel in lieu of detachable base, or to adjust the rear-facing angle of the seat.

Installing base (rear-facing only)

1. Confirm car seat is locked in its unfolded position.
2. Confirm adjustable bottom is flush with the bottom of the car seat.
3. Align posts with holes and insert base into the bottom of the car seat.
4. Slide base back until it reaches alignment mark on the bottom of the car seat and secures into place.
5. Push in the metal tab to lock base.

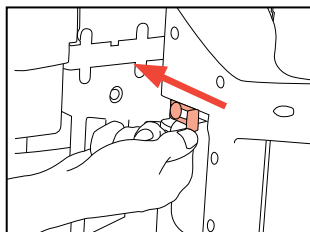
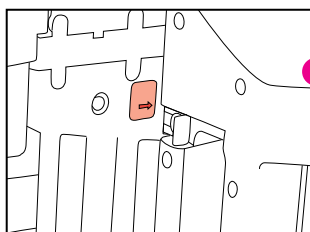
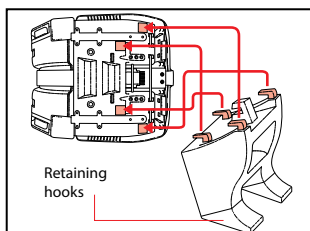

Removing Base

1. Pull metal tab out to unlock base.
2. Slide base forward (the opposite direction as shown in picture).
3. Pull base away from the bottom of the car seat.

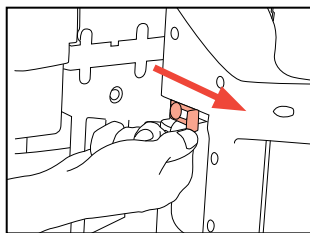

Rear-facing SuperLATCH™ Installation

WARNING:

- You **MUST** use car seat rear-facing if child is less than 1 year and weighs less than 20 pounds (minimum requirements).
- Diono and the American Academy of Pediatrics recommend keeping children rear-facing to the maximum rear-facing weight or height capacities of this car seat (40 pounds or head is less than 1.5 inches from top of shell).
- Consult your pediatrician for the correct angle for newborns and children without head control.
- Do not install by this method for a child weighing more than 35 pounds. Re-install Radian using the vehicle seat belt (*See pages 33-36*).
- Read vehicle manual regarding air bags, seating positions and warnings.
- Detachable base **MUST** be used with this car seat when it is rear-facing (*See page 30 for detachable base installation*).
- Make sure the bottom of the seat completely contacts the vehicle seat with no overhang.

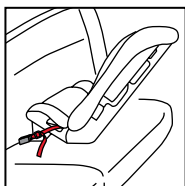

For step-by-step installation videos, please visit: www.youtube.com/DionoUSA

Important: Detachable base **MUST** be used with this car seat when it is rear-facing (*See page 30 for detachable base installation*).

1. Check vehicle manual for correct anchor location. Confirm vehicle seating location has its own LATCH anchors. If it does not, you must use vehicle seat belt installation (*See pages 33-36*).
2. Locate SuperLATCH™ connectors secured in storage compartment on restraint back. Press red release button to remove each SuperLATCH™ connector and webbing. Slide the narrow SuperLATCH™ attachment strap out of plastic strap guides on side of the seat. Loosen strap to extend its length.

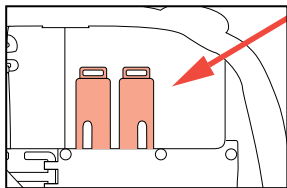

Rear-facing SuperLATCH™ Installation (cont.)

3. Slide the SuperLATCH™ through the opening above the rear-facing belt path label which is on the lower portion of the car seat. Be sure the SuperLATCH™ strap is flat and not twisted. Adjustment strap should be on the child's right side of car seat.

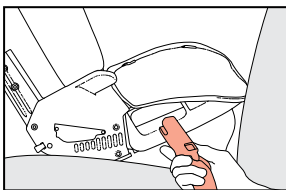

4. Place car seat so that both the seat bottom and feet of the detachable base are flat on the vehicle seat. Front of car seat should be up against back of vehicle seat.

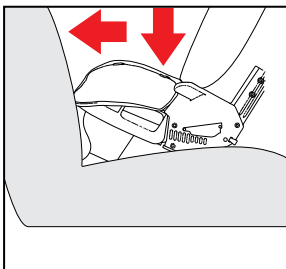

5. Connect both SuperLATCH™ connectors to the correct lower anchors in the vehicle seating position. The red button will "click" and pop up to confirm secure attachment to anchors. Red buttons should be facing upward for correct fit and easy access. To release, press the red button. Red button will stay down when not in use.

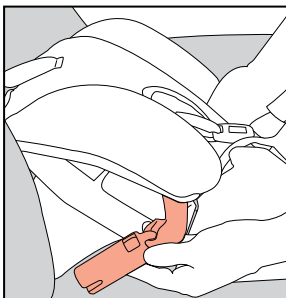

6. Push down in the middle where the child sits, while tightening the SuperLATCH™ strap. To check for a tight fit, grab the seat near the label that states "rear-facing belt path" with one hand and give it a moderate tug. It should move less than 1 inch side-to-side, back-to-front.

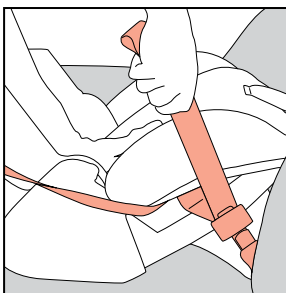

Tip: If available, add the rear-facing top tether connector strap to the appropriate anchorage and attach the top tether strap (See page 37 for installation instructions).

Rear-facing SuperLATCH™ Installation (cont.)

Important: It may be necessary to move front vehicle seat slightly forward to properly fit rear-facing car seat. The Diono Angle Adjuster may be purchased separately to adjust recline, if child can sit up unassisted and has full head control. Angle Adjuster is not appropriate for a newborn.

☐ See final checklist on page 51

Rear-facing Lap-Shoulder Belt Installation

⚠ WARNING:

- You **MUST** use car seat rear-facing if child is less than 1 year and weighs less than 20 pounds (minimum requirements).
- Diono and the American Academy of Pediatrics recommend keeping children rear-facing to the maximum rear-facing weight or height capacities of this car seat (40 pounds or head is less than 1.5 inches from top of shell).
- Consult your pediatrician for the correct angle for newborns and children without head control.
- Read vehicle manual to learn more about top tether anchors, air bags, seating positions, warnings, and how a vehicle seat belt locks.
- Detachable base **MUST** be used with this car seat when it is rear-facing (*See page 30 for detachable base installation*).
- Make sure the bottom of the seat completely contacts the vehicle seat with no overhang.



For step-by-step installation videos, please visit: www.youtube.com/DionoUSA

Important: Detachable base **MUST** be used with this car seat when it is rear-facing (*See page 30 for detachable base installation*).

1. Place car seat so that both the seat bottom and feet of the detachable base are flat on the vehicle seat. Front of car seat should be up against back of vehicle seat.

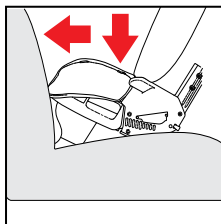

Rear-facing Lap-Shoulder Belt Installation (cont.)

- Slide the seat belt through the opening above the rear-facing belt path label which is on the lower portion of the car seat and insert it into the buckle. Be sure the belt is flat and not twisted. Check vehicle manual on how the seat belt locks.

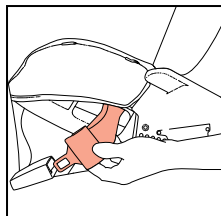
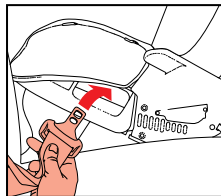

- Push down on the bottom of the car seat while pulling all the slack out of the belt. It's best to do this close to the buckle. Be sure belt is locked and the car seat does not move more than 1 inch side-to-side, front-to-back at the belt path.

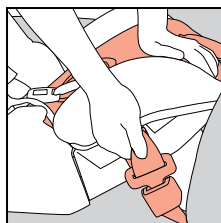

Tip: If available, add rear-facing top tether connector strap to appropriate anchorage and attach top tether strap (*See page 37 for installation instructions*).

Infant Support Cushion: You may use the cushions up to any weight for maximum comfort and support.

Important: It may be necessary to move front vehicle seat slightly forward to properly fit rear-facing car seat. The Diono Angle Adjuster may be purchased separately to adjust recline, if child can sit up unassisted and has full head control. Angle Adjuster is not appropriate for a newborn.

WARNING:

- Make sure vehicle seat belt is properly locked. If your seat belt does not lock, (*See page 20 for instructions on using the locking clip*).
- Failure to properly lock seat belt will result in an unsafe installation that will greatly increase the potential for injury or death to the child in a crash.
- Carefully read vehicle owner's manual to determine seat belt locking requirements or contact vehicle manufacturer.

See final checklist on page 51

Rear-facing Lap Belt Installation

WARNING:

- You **MUST** use car seat rear-facing if child is less than 1 year and weighs less than 20 pounds (minimum requirements).
- Diono and the American Academy of Pediatrics recommend keeping children rear-facing to the maximum rear-facing weight or height capacities of this car seat (40 pounds or head is less than 1.5 inches from top of shell).
- Consult your pediatrician for the correct angle for newborns and children without head control.
- Read vehicle manual to learn more about top tether anchors, air bags, seating positions, warnings, and how a vehicle seat belt locks.
- Detachable base **MUST** be used with this car seat when it is rear-facing (*See page 30 for detachable base installation*).
- Make sure the bottom of the seat completely contacts the vehicle seat with no overhang.



For step-by-step installation videos, please visit: www.youtube.com/DionoUSA

Important: Detachable base **MUST** be used with this car seat when it is rear-facing (*See page 30 for detachable base installation*).

1. Place car seat so that both the seat bottom and feet of the detachable base are flat on the vehicle seat. Front of car seat should be up against back of vehicle seat.
2. Slide the seat belt through the opening above the rear-facing belt path label which is on the lower portion of the car seat and insert it into the buckle. Be sure the belt is flat and not twisted. Check vehicle manual on how the seat belt locks.

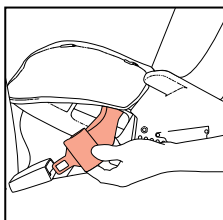
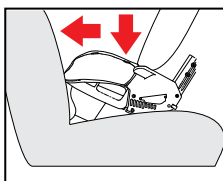

Rear-facing Lap Belt Installation (cont.)

3. Push down on the bottom of the car seat while pulling all the slack out of the belt. It is best to do this close to the buckle. Be sure belt is locked and the car seat does not move more than 1 inch side-to-side, front-to-back at the belt path.

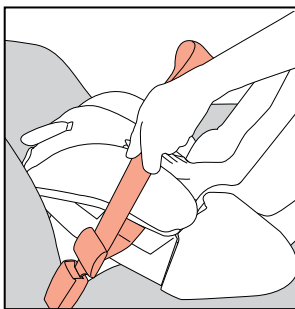

Tip: If available, add rear-facing top tether connector strap to appropriate anchorage and attach top tether strap (*See page 37 for installation instructions*).

Important: It may be necessary to move front vehicle seat slightly forward to properly fit rear-facing car seat. The Diono Angle Adjuster may be purchased separately to adjust recline, if child can sit up unassisted and has full head control. Angle Adjuster is not appropriate for a newborn.

WARNING:

- Failure to properly lock seat belt will result in an unsafe installation that will greatly increase the potential for injury or death to the child in a crash.
- Carefully read vehicle owner's manual to determine seat belt locking requirements or contact vehicle manufacturer.

 See final checklist on page 51

Rear-facing Top Tether Installation

⚠ WARNING:

- **DO NOT** modify vehicle without approval from vehicle manufacturer or authorized vehicle dealer.
- **DO NOT** attach rear-facing top tether connector strap to any movable mechanism of a vehicle seat. Consult vehicle manual for recommended rear-facing tether anchor locations.



For step-by-step installation videos, please visit: www.youtube.com/DionoUSA

Rear-facing Top Tether Connector Strap

⚠ WARNING:

- Rear-facing top tether connector strap is **ONLY** to be used in rear-facing installations.

With some vehicle models, the top tether may not fit structural parts of vehicle seat or there may not be a suitable anchorage point for top tether hook. It may be necessary to use the tether connecting strap to create a tether anchorage point:

1. Locate the track of vehicle seat that is bolted directly to vehicle frame.
2. Wrap tether connecting strap around the track, and thread metal 'D' ring through the loop at the end of the tether connecting strap. Pull strap to form a knot.
3. Now, use metal 'D' ring as an anchorage point for top tether metal hook.

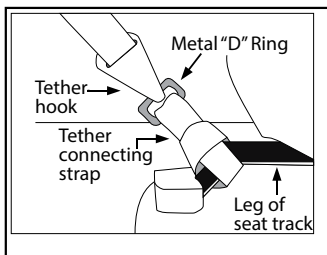

Note: Some vehicles have a tether anchor bracket attached to the vehicle seat frame which can be used instead of the tether connecting strap. If so, connect top tether metal hook directly to bracket. Check your vehicle manual or call the manufacturer.

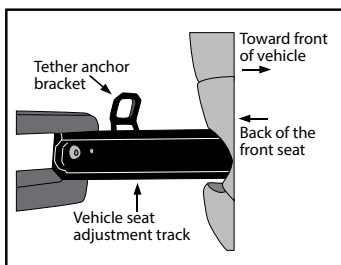

Safe Stop® Instructions

WARNING:

- **ALWAYS** use Safe Stop with forward-facing child under 40 pounds.
- **DO NOT** use with rear-facing child.
- **DO NOT** use Safe Stop with any other installation configuration.

Safe Stop is a load-limiting device designed to absorb energy and reduce impact to a smaller, forward-facing child. When not in use, attach Safe Stop to the fabric label sewn onto the upper back of the car seat cover.

1. Remove Safe Stop from the storage label located on the upper left back side of the car seat.

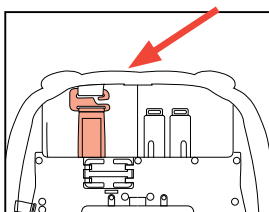

2. Remove harness straps from metal hook of harness adjuster strap.

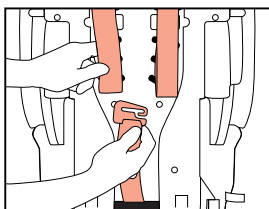

3. Thread both harness straps onto metal hook of Safe Stop. Connect left harness first then right.

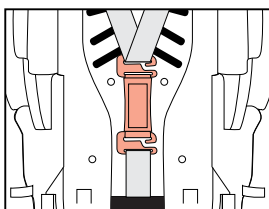

4. Thread bottom of Safe Stop onto metal plate of harness adjuster.

Forward-facing Adjustable Bottom

! WARNING:

- In forward facing installations, adjustable bottom **MUST** be lowered for children between 25 and 65 pounds. Adjustable bottom **MUST** be raised for children under 25 pounds.
- **DO NOT** adjust bottom for children under 25 pounds.

Important: Car seat must be locked in its unfolded position before operating adjustable bottom.



For step-by-step installation videos, please visit: www.youtube.com/DionoUSA

Lowering adjustable bottom

1. Lift bottom bar up and over the inside channel towards the car seat bottom to release.

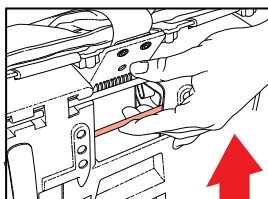

2. Confirm adjustable bottom is locked in its lowered position.

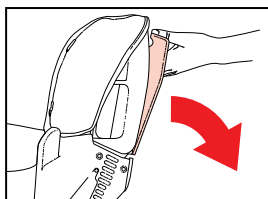

Raising adjustable bottom

1. Lift bottom bar up and over the inside channel (follow the "C" shape channel) away from the car seat bottom to securely close.

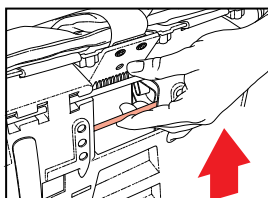

2. Confirm adjustable bottom is locked in its closed position.

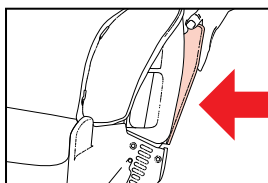

Forward-facing SuperLATCH™ Installation

WARNING:

- **DO NOT** install by this method for a child weighing more than 40 pounds.
- **DO NOT** use detachable base when car seat is forward-facing.
- **DO NOT** place infant in a forward-facing car seat until they are at least 1 year old and 20 pounds.
- Diono and the American Academy of Pediatrics recommend keeping children rear-facing to the maximum rear-facing weight or height capacities of this car seat (40 pounds or head is less than 1.5 inches from top of shell).
- **ALWAYS** use Safe Stop® for a forward-facing child who weighs below 40 pounds. **DO NOT** use Safe Stop® for children over 40 pounds (*See page 38*).
- Read vehicle manual regarding top tether anchors, air bags, seating positions and warnings.
- Adjustable bottom **MUST** be lowered for children between 25 and 65 pounds. Adjustable bottom **MUST** be raised for children under 25 pounds. (*See page 39*).

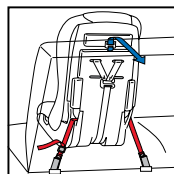

For step-by-step installation videos, please visit: www.youtube.com/DionoUSA

Check vehicle manual for correct anchor location. Confirm vehicle seating location has its own LATCH anchors. If it does not, you must use vehicle seat belt installation (*See pages 43-47*).

1. Locate SuperLATCH™ connectors secured in storage compartment on restraint back. Press red release button to remove each SuperLATCH™ connector and webbing. Slide the narrow SuperLATCH™ attachment strap out of plastic strap guides on side of the seat. Loosen strap to extend its length.

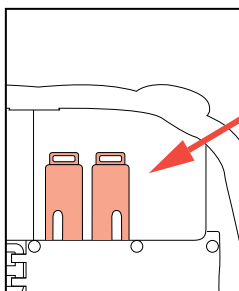

Forward-facing SuperLATCH™ Installation (cont.)

2. Unfasten fabric side panels and reach behind cover for easy access to belt path. Place car seat in forward-facing position with entire bottom flat on the vehicle seat and back of car seat flat against vehicle seat back.

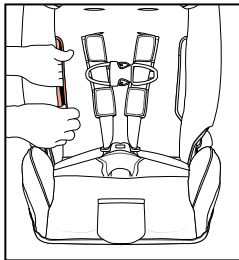

3. Route the Top Tether strap to the appropriate anchor and connect. Do not tighten until car seat is installed (*See pages 48 for Top Tether installation instructions*).

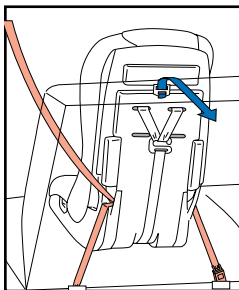

4. Slide the SuperLATCH™ through the opening above the forward-facing belt path label which is on the side middle portion of the car seat. Be sure the SuperLATCH™ strap is flat and not twisted. Adjustment strap should be on the child's left side of the car seat.

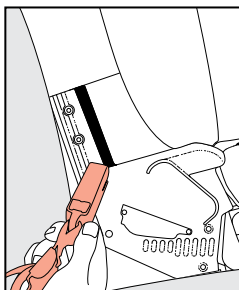

5. Connect both SuperLATCH™ connectors to the correct anchors in the vehicle seating position. The red button will "click" and pop up to confirm secure attachment to anchors. Red buttons should be facing upward for correct fit and easy access. To release, press the red button. Red button will stay down when not in use.

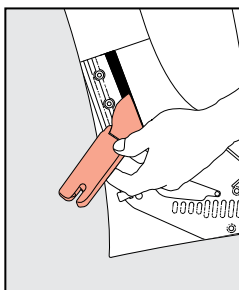

Forward-facing SuperLATCH™ Installation (cont.)

6. Push down on the car seat (where the child sits), while tightening the SuperLATCH™ strap. To check for a tight fit, grab the seat near the label that states “forward-facing belt path” with one hand and give it a moderate tug. It should move less than 1 inch side-to-side, back-to-front.

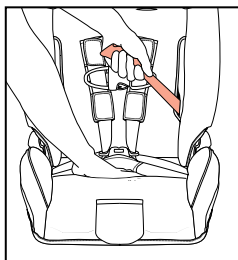

7. Remove slack from Top Tether strap if an appropriate anchor is available (*See page 48 for Top Tether installation*).

See final checklist on page 51

Forward-facing Lap-Shoulder Belt Installation

WARNING:

- **DO NOT** use detachable base when car seat is forward-facing.
- **DO NOT** place infant in a forward-facing car seat until they are at least 1 year old and 20 pounds.
- Diono and the American Academy of Pediatrics recommend keeping children rear-facing to the maximum rear-facing weight or height capacities of this car seat (40 pounds or head is less than 1.5 inches from top of shell).
- **ALWAYS** use Safe Stop® for a forward-facing child who weighs below 40 pounds. **DO NOT** use Safe Stop® for children over 40 pounds (*See page 38*).
- Read vehicle manual to learn more about top tether anchors, air bags, seating positions, warnings, and how a vehicle seat belt locks.
- Adjustable bottom **MUST** be lowered for children between 25 and 65 pounds. Adjustable bottom **MUST** be raised for children under 25 pounds (*See page 39*).



For step-by-step installation videos, please visit: www.youtube.com/DionoUSA

1. Unfasten fabric side panels and reach behind cover for easy access to belt path. Place car seat in forward-facing position with entire bottom flat on the vehicle seat and back of car seat flat against vehicle seat back.

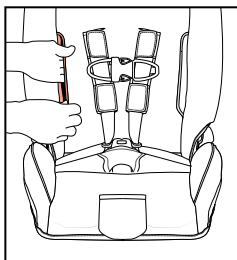

Forward-facing Lap-Shoulder Belt Installation (cont.)

2. Route the Top Tether strap to the appropriate anchor and connect. Do not tighten until car seat is installed (*See pages 48 for Top Tether installation instructions*).

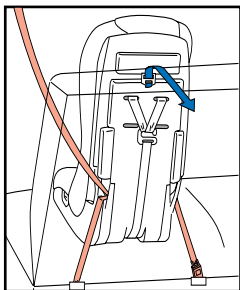

3. Slide the seat belt through the forward-facing belt path behind the fabric and buckle it. Be sure belt is not twisted. Put seat belt in locking mode, if necessary.

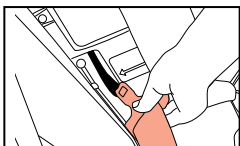

4. Pull shoulder portion of seat belt to remove slack so the lap portion is tightening down on the car seat. It is best to do this close to the buckle.

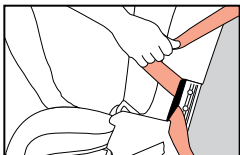

5. To check for a tight fit, grab the seat near the label that states "forward-facing belt path" with one hand and give it a moderate tug. It should move less than 1 inch side-to-side, back-to-front.

6. Remove slack from Top Tether strap if an appropriate anchor is available (*See page 48 for Top Tether installation*).

See final checklist on page 51

Forward-facing Lap Belt Installation

! WARNING:

- **DO NOT** use detachable base when car seat is forward-facing.
- **DO NOT** place infant in a forward-facing car seat until they are at least 1 year old and 20 pounds.
- Diono and the American Academy of Pediatrics recommend keeping children rear-facing to the maximum rear-facing weight or height capacities of this car seat (40 pounds or head is less than 1.5 inches from top of shell).
- **ALWAYS** use Safe Stop® for a forward-facing child who weighs below 40 pounds. **DO NOT** use Safe Stop® for children over 40 pounds. (See page 38).
- **ALWAYS** use forward-facing lap belt cushion when car seat is installed with LAP BELT **ONLY** and **NO** top tether for children 20-65 pounds.
- Read vehicle manual to learn more about top tether anchors, air bags, seating positions, warnings, and how a vehicle seat belt locks.
- Adjustable bottom **MUST** be lowered for children between 25 and 65 pounds. Adjustable bottom **MUST** be raised for children under 25 pounds (See page 39).

Installing the Lap Belt Cushion

Important: You **MUST** use the lap belt cushion:

- Your vehicle has a LAP BELT and **NO** top tether configuration
- Your child is forward-facing
- Your child weighs between 20 and 65 pounds

You **CANNOT** use the lap belt cushion in any other configuration.

1. Unbuckle the harness.

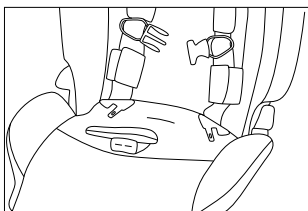

2. Remove the buckle pad by pulling it up and off the buckle.

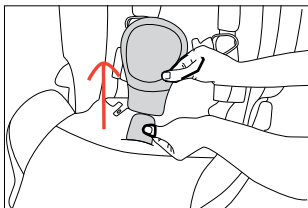

Forward-facing Lap Belt Installation (cont.)

3. Slide metal buckle through the slot in the lap belt cushion that matches the slot position used on the seat bottom.

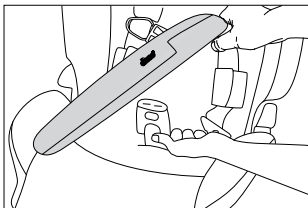

4. Pull upward on the buckle to confirm it is locked in place. Reinstall the buckle pad.

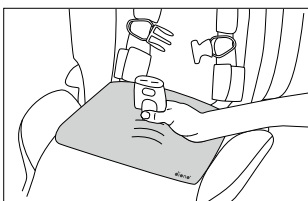

5. The child may now be placed in the seat and harnessed per directions in the manual. Please note that it may be necessary to adjust the harness straps for a proper fit.

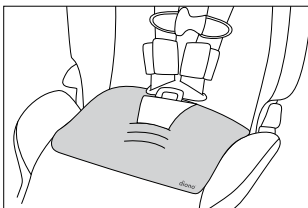

Installing with the Lap Belt



For step-by-step installation videos, please visit: www.youtube.com/DionoUSA

1. Unfasten fabric side panels and reach behind cover for easy access to belt path. Place car seat in forward-facing position with entire bottom flat on the vehicle seat and back of car seat flat against vehicle seat back.

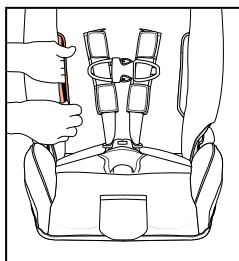

Forward-facing Lap Belt Installation (cont.)

2. If available, route the Top Tether strap to the appropriate anchor and connect. Do not tighten until car seat is installed (*See pages 48 for Top Tether installation instructions*).

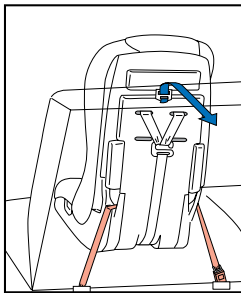

3. Slide the seat belt through the forward-facing belt path behind the fabric and buckle it. Be sure belt is not twisted. Put seat belt in locking mode, if necessary.

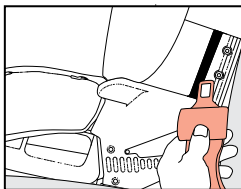

4. Push down on the bottom of the car seat while pulling all the slack out of the belt. It is best to do this close to the buckle. Be sure belt is locked and the car seat does **NOT** move more than 1 inch side-to-side, front-to-back at the belt path.

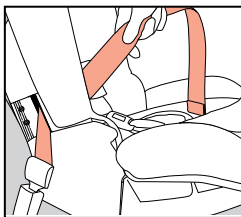

5. To check for a tight fit, grab at label that states "forward-facing belt path" with one hand and give it a moderate tug. It should move less than 1 inch side-to-side, back-to-front.
6. Remove slack from Top Tether strap if an appropriate anchor is available (*See page 48 for Top Tether installation*).

See final checklist on page 51

Forward-facing Top Tether Installation

WARNING:

- In forward-facing installations, attach top tether to approved vehicle tether anchorage points **ONLY**, as labeled by vehicle manufacturer.
- If vehicle does not have tether anchorage points, consult vehicle owner's manual or contact vehicle manufacturer. **DO NOT** modify vehicle without approval from vehicle manufacturer or authorized vehicle dealer.



For step-by-step installation videos, please visit: www.youtube.com/DionoUSA

1. Before installing car seat, remove top tether from storage compartment and fully extend.
2. Tilt buckle and pull top tether adjuster strap to fully extend.
3. Loosely attach top tether to an approved anchorage point in the vehicle using the hook at end of top tether strap.
4. Install car seat as shown in appropriate installation section. Be sure installation is tight.
5. After installing car seat, pull top tether adjuster strap to remove all slack. Some movement at the top of the car seat is acceptable as long as the top tether strap remains tight.

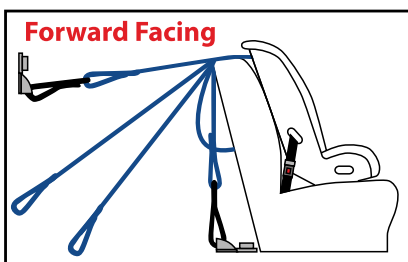

Important: Diagram shows a variety of places you might find a top tether anchor. Consult vehicle manual to locate correct anchor.

Booster Mode Installation

WARNING:

- Add-on child restraint systems should be securely belted to the vehicle, even when they are not occupied, since in a crash an unsecured child restraint system may injure other occupants.
- **DO NOT** use SuperLATCH™ if installation interferes with vehicle seat belt.
- **DO NOT** use as a booster with child under 50 pounds and under 40 inches tall and if child's shoulders are below the 4th harness position.
- **DO NOT** use as a booster unless harness straps and buckle are removed.
- **DO NOT** use as a booster with only a vehicle lap belt.
- Warning! Use **ONLY** the vehicle's lap and shoulder belt system when restraining the child in this booster seat. Never use lap belt only as your child will not be adequately restrained in a crash.
- If lap and shoulder belt portions of seat belt and seat belt buckle are not all correctly positioned, car seat is **NOT** properly installed as a booster.
- While crash testing indicates Belt Position Booster mode meets all Federal Motor Vehicle Safety Standards requirements, all vehicles **DO NOT** simulate the crash test bench. Therefore, we recommend to use Booster Mode only if the seat belt retracts freely and fully on its own. If **NOT**, continue to use the five point harness system which gives your child optimum protection.



For step-by-step installation videos, please visit: www.youtube.com/DionoUSA

This car seat may also be configured for use as a belt positioning booster.

1. Remove harness (*See page 26, steps 1-5*), then remove buckle (*See page 27, steps 1-4*).
2. Place car seat in forward-facing position with entire bottom flat on the vehicle seat and back of the car seat flat against the vehicle seat back.
3. If available, secure car seat with SuperLATCH™ and/or top tether. This provides a secure installation and keeps the seat secure when not occupied.
4. Properly position the child in the car seat: sitting upright and all the way back in the car seat.

Booster Mode Installation (cont.)

- Fasten lap-shoulder belt across child: lap portion of seat belt should rest within both lower belt guides and buckle located on the outside of the car seat.



- Place shoulder belt portion so that belt lays properly across child's collarbone, interior to the shoulder. Use the upper belt guide to properly position the shoulder belt.



Check periodically to ensure your child has not moved out of position and loosened the shoulder belt.

- Make sure seat belt is not twisted and remove slack from seat belt so it lays flat, smooth and snug across the child in all locations.

Proper Buckle Position

Seat belt buckle should be correctly positioned on the outside of the lower belt guide. If seat belt buckle is pulled across lower belt guide and into the car seat, this is incorrect and another seating position within the vehicle should be chosen. **If child cannot stay in correct position, we recommend continuing use in harness mode only.**

Final Checklist

For correct installation

- ✓ **Be familiar with the parts of the car seat.**
(See pages 12-13)
- ✓ **LATCH Installations:** Be sure SuperLATCH™ connectors are securely attached to correct anchors and strap is pulled tight (See pages 31-33 for rear-facing and pages 40-42 for forward-facing).
- ✓ **Seat Belt Installation:** Be sure the seat belt is **LOCKED** and pulled tight (See pages 33-36 for rear-facing and pages 43-47 for forward-facing). If your vehicle was manufactured before 1996, you may need to use a locking clip to lock the seat belt (See page 20).
- ✓ **DO NOT USE** the seat belt and the SuperLATCH™ together for installation.
- ✓ **Rear-facing:** Grab at rear-facing belt path label, and give a tug. If seat moves more than 1 inch side-to-side, front-to-back, repeat steps for installation or choose another seating position. Do not grab at top of seat to check for a tight fit.
- ✓ **Forward-facing:** Grab at forward-facing belt path. If seat moves more than 1 inch side-to-side, front-to-back, repeat steps for installation or choose another seating position.
- ✓ **Using the Top Tether Strap** for rear-facing and forward-facing if appropriate place is available. This car seat meets crash test standards with and without Top Tether (See pages 37 and 48).
- ✓ **Always check** for a tight installation before each ride.

Check Your Work

There are certified Child Passenger Safety Technicians across the country available to help you.

Go to http://safekids.org/events/field-type/check_event to locate your nearest technician. Car crashes are the #1 cause of unintentional death and injuries to children. Please be sure your child's car seat is installed properly. Buckle up all other passengers

Important: If the car seat does not stay securely installed, it means that the car seat installation is **NOT** safe. You **MUST** re-install the car seat according to the car seat instructions and the vehicle owner's manual. In order to achieve proper installation you may need to choose an alternate installation method or seating location within the vehicle.

Video Instructions

WARNING:

- The video instructions referenced below are provided for your reference to ease installation. **YOU MUST** read and understand all information in this manual and on the labels of your car seat for correct use.



For step-by-step installation videos, please visit: www.youtube.com/DionoUSA

Carrying the Car Seat

⚠ WARNING:

- **DO NOT** carry the car seat by harness adjuster strap. This can damage the mechanism and the webbing.
- Only the shoulder carry straps made by Diono are approved for use with this car seat.

There are four ways to carry the car seat:

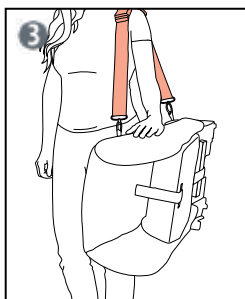
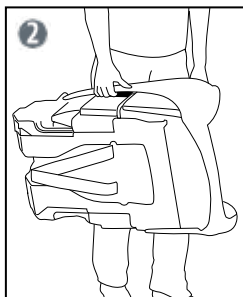
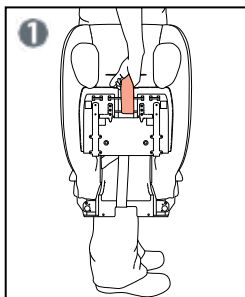

1. Red carry strap
2. Plastic side
3. Shoulder strap* (connect shoulder strap to carry strap loop)
4. Backpack (connect shoulder straps* to lower webbing anchors on both sides and upper carry strap loop on back of car seat)

* Padded shoulder strap(s) available as a separate accessory, not included.

Cup Holder (not included)

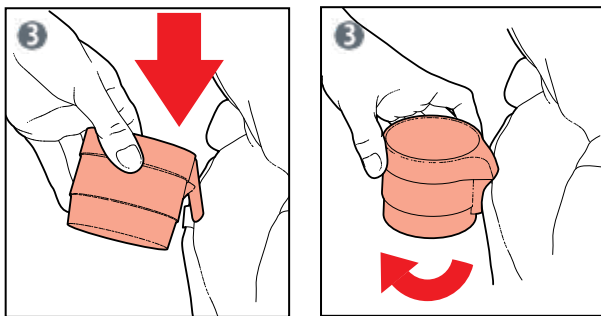

1. Additional cup holders can be purchased as added accessories and attached to either side.
2. Each side has one cup holder slot.
3. Adjust side to its outward position, locate tab on fabric cover, and insert cup holder stem into receiving slot on top of arm rest and push down until it is securely engaged and twist to lock in place.

Tip: Before inserting the cup holder, lift the cover from the expandable side to help you locate the holes that the cup holder is inserted into.

Car Seat Cover

Tip: It is not necessary to remove buckle tongues or chest clip from harness straps when removing and replacing car seat cover. If possible, take pictures while you are removing the cover in order to replace the cover easily.

Removing car seat cover

1. Remove the harness buckle.
2. Remove harness shoulder straps from back of car seat, but leave them attached to the car seat.
3. Undo buttons securing cover to inside of car seat bottom.
4. Unhook clips (bottom, side, top) securing cover to front of car seat.
5. Carefully remove upper portion of cover from car seat taking care not to damage the white EPS foam panels, and then remove cover from bottom portion of the car seat.

Replacing car seat cover

1. Place cover on top of car seat.
2. Secure buttons to inside of car seat bottom.
3. Hook fasteners (bottom, side, top) securing cover to front of car seat.
4. Attach harness shoulder straps to back of car seat (*see page 26*).
5. Insert harness buckle (*see page 28*).

Cleaning and Maintenance

Cleaning and maintenance of release mechanism and locking bolts

Periodically inspect release levers and locking bolts for cleanliness and proper functioning: When release levers are lifted, release levers and locking bolts should spring back immediately and completely.

! WARNING:

- **DO NOT** use car seat if release levers and locking bolts do not function properly. There may be excessive build-up of debris that cannot be removed or internal damage to the locking mechanisms that could prevent safe functioning.
- **DO NOT** oil or lubricate any part of the car seat.
- **DO NOT** use car seat if there is any appearance of rust on any metal surface.

Tip: Remove debris from release mechanism areas with soft bristled brush.

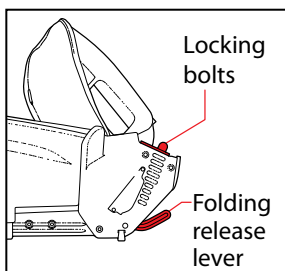

Removing dried liquids or food requires more thorough cleaning

1. Secure car seat restraint in its folded position (*see pages 7-9, folding/unfolding car seat*).
2. Clean with damp cloth only. Wet cloth with warm water and wring thoroughly so it is **NOT** dripping water.
3. Towel dry.
4. Confirm areas are free of debris and release mechanisms function properly.

Important: **ONLY** use water to clean. **DO NOT** use solvents, bleach, soap, abrasive cleaners or any detergents.

Cleaning and Maintenance (cont.)

Cleaning the plastic shell

1. Clean with damp cloth only. Wet cloth with warm water and mild soap. Wring cloth thoroughly so it is **NOT** dripping water.
2. Towel dry.
3. Confirm areas are free of debris and release mechanisms function properly.

Important: DO NOT use solvents, bleach, or abrasive cleaners.

Cleaning the cover and lap belt cushion

1. Remove the memory foam and foam from lap belt cushion, **DO NOT** machine wash.
2. Hand wash or machine wash cover only in front loading machine or top loader with no agitator.
3. Line or air dry.

Important: DO NOT bleach. **DO NOT** wash cover in hot water (*See page 55 for cover removal and replacement*).

Cleaning harness adjuster

Periodically inspect harness adjuster for cleanliness and proper functioning. When lifted, harness adjuster should spring back immediately.

Tip: Remove debris from release mechanism areas with soft bristled brush.

1. Clean with damp cloth only. Wet cloth with warm water and wring thoroughly so it is **NOT** dripping water.
2. Towel dry.
3. Confirm areas are free of debris and release mechanisms function properly.

Important: ONLY use water to clean. **DO NOT** use solvents, bleach, soap, abrasive cleaners or any detergents. **DO NOT** attempt to disassemble the harness or unthread adjuster mechanism.

Cleaning and Maintenance (cont.)

Cleaning harness straps

1. Clean with damp cloth only. Wet cloth with warm water and mild soap. Wring cloth thoroughly so it is **NOT** dripping water.
2. Towel dry.

Important: DO NOT use solvents, bleach, or abrasive cleaners. **DO NOT** soak or submerge the harness webbing.

Cleaning the buckle

If child eats or drinks in car seat, periodically clean harness buckle to ensure proper functioning.

Tip: Remove debris from release mechanism areas with soft bristled brush.

1. Remove buckle from car seat (*See pages 27-28*).
2. Carefully rinse **ONLY** the buckle mechanism in mildly hot water or soak overnight to loosen dried liquid or hardened food debris. **DO NOT** get the buckle strap wet.
3. Towel dry.
4. Confirm proper buckle functioning: repeatedly fasten and unfasten buckle with both tongues. If no 'click' is heard confirming proper engagement after inserting each buckle tongue, repeat cleaning procedure.

Important: ONLY use water to clean buckle. **DO NOT** use solvents, bleach, soap, abrasive cleaners or any detergents. **DO NOT** soak or submerge the buckle webbing.

Replacing Harness Straps

1. Secure metal tongues into the buckle. Remove harness straps from the metal hook on the back of the seat.

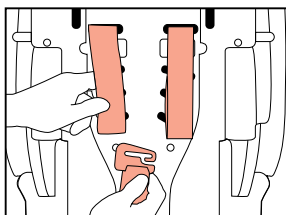

2. Pull the straps out from the back of the seat. Remove the harness pads and chest clip from each side.

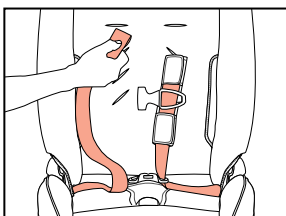

3. Slide the harness strap out of the metal tongues.

4. Using a Phillips head screwdriver, take out screws and remove access panels on both sides of car seat bottom.

5. Remove old harness straps from seat.

6. Insert new harness strap through slot in metal frame (**Figure 6a**), pull strap until metal D-ring is inside the cavity (**Figure 6b**).

7. Refasten access panels in place with screws.

8. Slide shoulder harness straps through the metal tongues.

9. Attach chest clip and harness pads to each harness strap.

10. Slide the harness straps into the back of the car seat and attach to the metal hook.

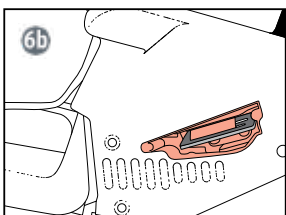
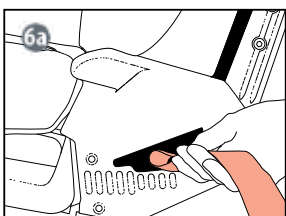
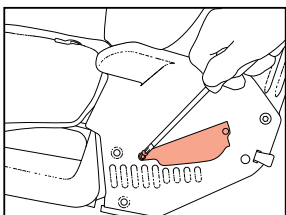

Aircraft Installation

Important:

- This seat is certified by the Federal Aviation Administration (FAA) for use **ONLY** as a harnessed restraint. This restraint is **NOT** certified for aircraft use in belt-positioning booster mode. Aircraft seats do not have shoulder belts which are required for booster seats. Call airline to confirm the car seat will fit your specific aircraft. Diono's Angle Adjuster (sold separately) may be beneficial. Seat belt extender will be necessary for rear-facing installation.
- Do **NOT** use lap belt cushion for aircraft installation.



For step-by-step installation videos, please visit: www.youtube.com/DionoUSA

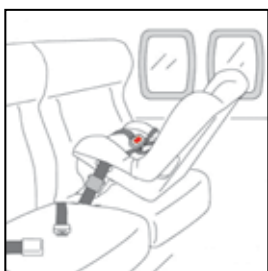

Rear-facing aircraft installation

- Adjust seat belt buckle to its shortest length to ensure buckle is accessible for release.
- Ask flight attendant for 'seat belt extender,' and then use this extender to adjust seat belt length.
- Follow remaining installation instructions (*See page 35*).

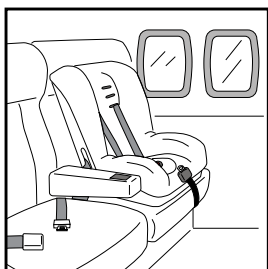

Forward-facing aircraft installation

- Follow installation instructions (*See page 46*). **DO NOT** use top tether for aircraft installation.

Warranty Information

Important: If you purchased your seat online, check with your retailer on their return policies and keep the original box and packaging and save purchase receipt for your records.

Diono, LLC. warrants its proprietary products to the original end-user retail purchaser as follows:

LIMITED ONE-YEAR WARRANTY This product is warranted against physical defects in materials or workmanship as a result of normal use for one year from the date of original retail purchase. Proof of purchase is required. The exclusive remedy for this warranty is that Diono will upon return of the product to Diono and determination of any such defect, at its sole option replace, repair or provide replacement components for this product. Diono reserves the right to discontinue or change fabrics, parts, models or products, or to make substitutions. To make a claim under this warranty, contact **Diono Customer Care at 1-855-463-4666.**

Visit **us.diono.com** for complete warranty information and details.

Revised 10/2017

Notes







radian® r100

all-in-one convertible

product: **radian® r100**
all-in-one convertible

mfg. by: Diono US
14810 Puyallup Street E
Suite 200
Sumner, WA 98390

Customer Care
Tel: 1 855 463 4666
us.diono.com



@dionoUSA