



# Radian<sup>®</sup> 3QXT+<sup>®</sup>

## Car Seat Instructional Manual

All-In-One Convertible

4-120 lb (1.8-54 kg)



**READ INSTRUCTION MANUAL**

before using this car seat

# CONTENTS

## WE LOVE TO HELP

**Hello there, Welcome to the Diono family!** We've created this lovingly engineered car seat to help keep your child comfortable and safe with all of the goods and none of the gimmicks. ***We look forward to lending a helping hand each and every day.***



**Any questions?**

**Diono U.S.: 1-855-463-4666**

**Diono Canada: 1-866-954-9786**

## **REGISTER THIS CAR SEAT**

	<b>6</b>
Certification	8
Safe Use Guide	9-13
Warnings & Safe Practices	14-17
Car Seat Use After Collision	18-19
Parts	20-21
Vehicle Seating Locations	22-23
<b>Vehicle Seat Belt Types</b>	<b>24-29</b>
Latch Plates	
Retractors	
How To Lock Your Retractor	

# CONTENTS

LATCH/UAS	30
Side Impact Management	31
<b>First Setup</b>	<b>32-41</b>
A. Unfolding Car Seat	
B. Harness Strap Placement	
C. Buckle Slot Placement	
D. Changing Harness Position	
E. Buckle Strap Slot Change	
F. Harness Tightening	
G. Adjusting Headrest	
<b>REAR-FACING INSTALLATION</b>	<b>42-55</b>
Detachable Rear-Facing Base	
Seat Bights	
Anti Rebound Panel (ARP)	
Infant Support	
Newborn Harness Pads	
Newborn Protection Insert	
LATCH/UAS Installation	
Lap/Shoulder Belt Installation	
Lap Belt Installation	
<b>FORWARD-FACING INSTALLATION</b>	<b>56-72</b>
Top Tether	
Safe Stop	
Adjustable Bottom	
Anti Rebound Panel (ARP)	
80/20 Overhang Guidance	

# CONTENTS

LATCH/UAS Installation	
Lap Belt Cushion	
Lap/Shoulder Belt Installation	
Lap Belt Installation	
<b>BOOSTER MODE INSTALLATION</b>	<b>74-77</b>
Aircraft Installation	78
<b>Comfort Features</b>	<b>79-81</b>
Cup Holder	
Expandable Side Wings	
Toddler Liner	
Harness Strap Removal	82-83
Harness Strap Replacement	84-85
Folding Car Seat	86-87
Seat Cover Removal	88-91
Care and maintenance	92-93
Warranty	94-96

# NOTES

## REGISTER THIS CAR SEAT

Please take a few moments to promptly fill out and return the attached card or register online using the direct link to the manufacturer's registration website provided.

Child restraints could be recalled for safety reasons. You must register this restraint to be reached in a recall. Send your name, address, e-mail address if available, and the restraint's model number and manufacturing date to:

**Diono U.S., PO Box 77129, Seattle, WA 98177**

or call 1-855-463-4666 or register online at: <http://diono.com/product-registration/>

**Diono Canada ULC, 2160 S. Service Rd. W., Oakville, ON L6L 9Z9**

**Canada** or call 1-866-954-9786 or register online at: <http://diono.ca/product-registration/>

For future reference, in the case of a change of address, please take a moment to fill out the following information:

**Model Number:** \_\_\_\_\_

**Manufacture Date:** \_\_\_\_\_

This information can be found either on the registration card or on the manufacturing label located on the seat.

## OUR STORY

Time. It goes so fast... Who would have thought that over two decades have passed since we first stepped out into the world and started a business dedicated to family travel.

Well the world has changed a lot, but we're proud to say that we haven't (sure we've grown up), but we are still as passionate about what we do today as we were back then.

Our story is 'made of Seattle', a city like no other. This is a place where creative minds & innovators rub shoulders within a landscape of adventure; a place where being 'a little different', is the everyday norm.

With a love for design and an understanding of modern parenting, we strive to create amazing products, so that you and your little ones can celebrate the joy in every journey.

People who own Diono products can be found in all four corners of the big, blue, green ball we all call home. Some are fans & followers, some are supporters, tweeters, social media magicians, miracle moms and devoted dads.

Without your passion, pictures, words and stories, we would never hear your voice. So tell us about your patch of grass, and join in the hustle and bustle at [diono.com](http://diono.com).

share your journey @diono social  
or find the latest news



## CERTIFICATION



This child restraint system conforms to all applicable requirements of U.S Federal Motor Vehicle Safety Standards (FMVSS) 213 and Canada Motor Vehicle Safety Standards (CMVSS) 213, 213.1, 213.2.



This child restraint is certified for use in aircraft only when in harness mode.



This child restraint is not certified for use in aircraft when used in booster mode. Aircraft seats do not have shoulder belts which are required for use with this booster.

Diono and the US Federal Aviation Administration (FAA) strongly urge you to secure your child in a child restraint system (CRS) or device for the duration of your flight. Please contact the airline for their specific policies.



## SAFE USE GUIDE



**WARNING** – failure to follow these instructions and the product labels can result in serious injury or death to your child.

**Your child's safety depends on you. Death or serious injury can occur.**

No child restraint can guarantee protection from injury in every situation, but proper use helps to reduce the risk of serious injury or death.

Carefully read and understand all instructions and warnings in this manual. Your child's safety depends on you knowing how to setup, install and use this child restraint properly.

Choose the correct mode of use for your child, depending on their weight and height.

This child restraint is designed for use only with children who weigh 4–120 lb (1.8–54 kg) and whose height is 57 in (144 cm) or less in the following modes.

## SAFE USE GUIDE

**Rear-facing:** 4–50 lb (1.8–22.7 kg) and whose height is 18–44 in (46–112 cm).

**Forward-facing:** 22–65 lb (10–29.5 kg) and whose height is 30–57 in (76–145 cm).

**Booster:** 40–120 lb (18–54 kg) and whose height is 40–57 in (101–145 cm).

- ✓ **DO NOT** place this car seat rear-facing in a vehicle seating location with an active front air bag.
- ✓ Choose the proper car seat belt path
  1. **REAR-FACING SECTION**
  2. **FORWARD-FACING SECTION**
  3. **BOOSTER MODE SECTION**
- ✓ Choose a suitable location for this car seat in your vehicle. **Review your vehicle seating locations.**
- ✓ Install this car seat tightly in your vehicle.
- ✓ Secure harness snug and flat on your child.

# SAFE USE GUIDE

## CAR SEAT WEIGHT GUIDE

### WEIGHT

120 lb (54 kg)

65 lb (29.5 kg)

50 lb (22.7 kg)

40 lb (18 kg)

22 lb (10 kg)

4 lb (1.8 kg)

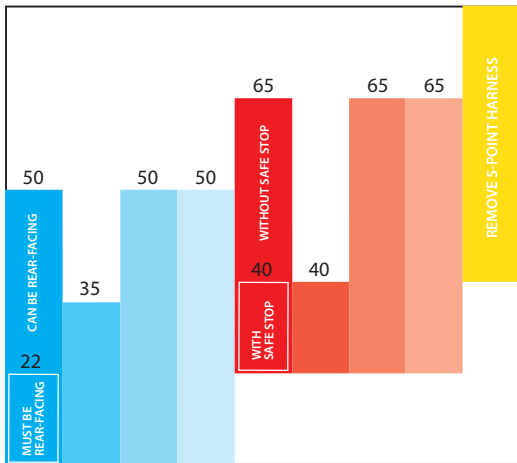

**INSTALLATION**

**REAR-FACING**

USE DETACHABLE REAR-FACING BASE

LATCH/UAS

LAP/SHOULDER BELT

LAP BELT

**FORWARD-FACING**

LATCH/UAS

LAP/SHOULDER BELT

LAP BELT w/ TOP TETHER

**BOOSTER**

LAP/SHOULDER BELT ONLY

## SAFE USE GUIDE

**Infants who weigh less than 22 lb (10 kg) or are under 1 year old, MUST use this child restraint rear-facing.**

For newborn infants, you must consult the infant's doctor before using this child restraint. A newborn infant may have difficulty breathing or have other medical problems when placed in a seated position.

***Before installing this child restraint in a vehicle, be sure to also check the vehicle owner's manual for information on proper installation.***

Check all installation configurations before discarding the box. Diono cannot guarantee proper fit in all vehicles.

**According to accident statistics, children are safer when properly restrained in the vehicle's rear seating positions than in the front seating positions.**

## SAFE USE GUIDE

**Rear-facing:** Harness straps **MUST** be at or just below the child's shoulders. Top of head must be 1.5 in (3.8 cm) below the top of the car seat shell.

**Forward-facing:** Harness straps **MUST** be above the child's shoulders. Top of child's ears **MUST** be below top of car seat shell.

**Booster mode:** Child **MUST** be secured using **ONLY** the vehicle lap/shoulder belt. Child **MUST** weigh at least 40 lb (18 kg), with shoulders positioned at or above the 4th slot and remain properly seated for the entire ride.

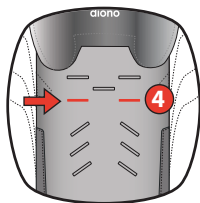

**ALWAYS** install this child restraint in the back seat. The back seat is the safest place for children 12 and under.

**NEVER** leave car seat unsecured in your vehicle even when it is unoccupied. It could injure other occupants in a sudden stop or collision.



## **!WARNING!**



**Never place this child restraint rear-facing in a vehicle seating location with an active front air bag. Death or serious injury may occur.** If an air bag inflates, it can hit the child or child restraint with enough force to cause serious injury or death to your child. For vehicles with side passenger air bags, refer to your vehicle owner's manual for information on your child restraint installation.

Take care to secure the child properly. Snugly adjust the harness straps provided with this child restraint around your child. A snug strap should not allow any slack. It should lay in a relatively straight line without sagging. It does not press on the child's skin or push the child's body into an unnatural position.

For any questions or concerns please contact diono at:

**Diono U.S.:**

1-855-463-4666 or online at [www.diono.com](http://www.diono.com)

**Diono Canada:**

1-866-954-9786 or online at [www.diono.ca](http://www.diono.ca)



- **DO NOT** use child restraint in any configuration not shown in the instructions.
- **DO NOT** modify your child restraint.
- **NEVER** install in a seat that is rear-facing, side-facing or on the back of a folded down vehicle seat.
- **ALWAYS** secure this child restraint with the vehicle's child restraint anchorage system (LATCH/UAS) if available OR the vehicle seat belt.
- **NEVER** use the restraint system in a vehicle seating position where it cannot be secured tightly. A loosely installed restraint system will not protect your child in a collision.
- **DO NOT** use the LATCH/UAS system to attach this child restraint rear-facing when restraining a child weighing more than 35 lb (15.8 kg) or forward-facing when restraining a child weighing more than 40 lb (18 kg).
- **ALWAYS** use the top tether strap when installed forward-facing.



## **!WARNING!**



- **DO NOT** use any accessories, inserts or products not included with this child restraint, unless approved by Diono. Items not tested with this child restraint could injure your child.
- **NEVER** remove harness from child restraint without following the proper removal and installation instructions (*see pg 80*).
- **DO NOT** use child restraint without seat cover installed.
- **ALWAYS** check seat belt or LATCH/UAS connectors to ensure all buckles are securely latched.
- **NEVER** leave child unattended. Do not allow children to play in or around the child restraint. Child may become tangled in harness straps and suffocate or strangle.
- **ALWAYS** keep child properly secured in harness whenever child is in child restraint.





## **EXPIRATION**

- **DO NOT** use the child restraint if any part is damaged or broken, expired (over ten years from date of purchase), missing instructions, missing parts, or if the straps are cut, frayed, or damaged in any way. Call to find out if the damaged part or parts can be replaced.

**Diono U.S.: 1-855-463-4666**

**Diono Canada: 1-866-954-9786**

## **SAFE PRACTICES**

- **DO NOT** leave loose objects, such as books, bags, etc., in the back of the vehicle. In the event of a sharp turn, sudden stop, or collision, loose objects can be thrown around and possibly cause serious injury to vehicle occupants.
- **ALWAYS** check all surfaces of restraint before securing your child. In warm weather, child restraints can become very hot. Do not allow children to play with vehicle seat belts.

# CAR SEAT USE AFTER A COLLISION

## UNITED STATES

The U.S. National Highway Traffic Safety Administration (NHTSA) recommends that car seats be replaced following a **MODERATE** or **SEVERE** collision in order to ensure a continued high level of collision protection for child passengers. In the U.S., car seats do not automatically need to be replaced following a **MINOR** collision.

**NHTSA** defines a **MINOR** crash as one in which **ALL** of the following apply:

- The vehicle was able to be driven away from the crash site.
- The vehicle door nearest the car seat was not damaged.
- None of the passengers in the vehicle sustained any injuries in the crash.
- If the vehicle has air bags, the air bags did not deploy during the crash; **and**
- There is no visible damage to the car seat.

**NEVER** use a car seat that has been involved in a **MODERATE** or **SEVERE** collision.

# CAR SEAT USE AFTER A COLLISION

## CANADA

- **DO NOT USE THIS CHILD RESTRAINT SYSTEM IF IT HAS BEEN IN A VEHICLE ACCIDENT.**
- **Transport Canada designates that you MUST replace this child restraint if it has been involved in a collision.**
- You must dispose of your child seat or booster seat if the child seat was in a vehicle during a crash. Even if the child seat was empty or was not directly hit, it may be damaged.
- You must dispose of your child seat or booster seat if the shell is cracked or the webbing of the child car seat is frayed, torn or discolored.

# PARTS

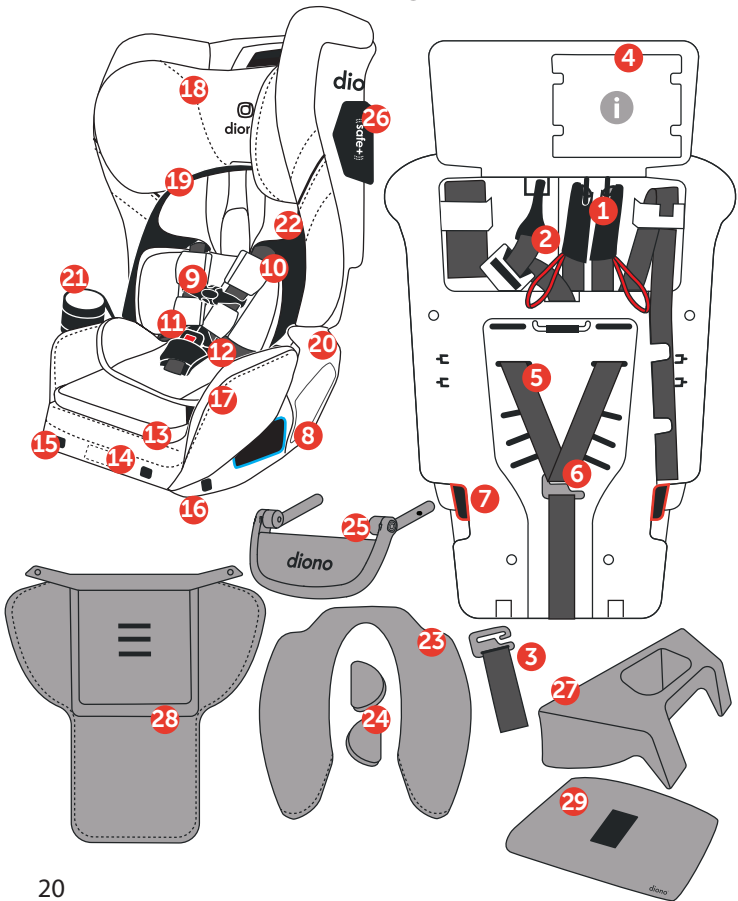

## PARTS

1. LATCH/UAS  
**Located under flap**
2. Top Tether  
**Located under flap**
3. Safe Stop
4. Instruction Manual Storage  
**Located under flap**
5. Harness Straps
6. Harness Strap Hook
7. **Forward-Facing** Belt Path
8. **Rear-Facing** Belt Path
9. Chest Clip
10. Harness Pads
11. Buckle
12. Buckle Pad
13. Memory Foam Cushion
14. Harness Adjust Strap  
& Silver Release Button
15. Anti-Rebound Panel Slots
16. Anti-Rebound  
Panel Release
17. Expandable Side Wings
18. Adjustable Headrest
19. Booster Shoulder  
Belt Guides
20. Booster Belt Guide
21. Cup Holder x2
22. Infant Support
23. Newborn Protection Insert
24. Newborn Harness Pads
25. Anti-Rebound Panel (ARP)
26. Side Impact  
Management Pod
27. Rear-Facing Base
28. Toddler Liner
29. Lap Belt Cushion

**U.S. Only**

## VEHICLE SEATING LOCATIONS

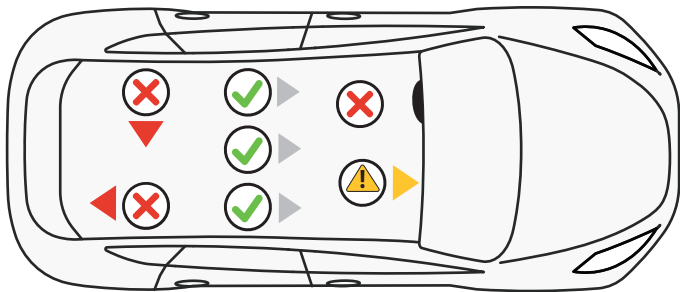

### INSTALL CHILD RESTRAINT CORRECTLY

**NEVER** place this child restraint rear-facing in a vehicle seating location with an active frontal air bag. If the airbag inflates, it can cause serious injury or death to your child. For vehicles with side air bags, refer to your vehicle owner's manual for information on your child restraint installation.

## VEHICLE SEATING LOCATIONS

The safest seating position is one that works best for your specific child restraint, family and vehicle model.

Before installing this child restraint you must determine the method of installation and the best vehicle seating position for that method. This child restraint can be installed either using LATCH/UAS or the Vehicle Seat Belt.

**DO NOT** install using both methods at the same time.

When determining whether the child restraint can be used with vehicle LATCH/UAS anchors in the rear center seating position, it is critical that you refer to your vehicle owner's manual. If the child restraint does not install best in the rear center seating location, it is recommended to move to one of the outboard seating positions.

Vehicle  
**LATCH/UAS**  
anchors

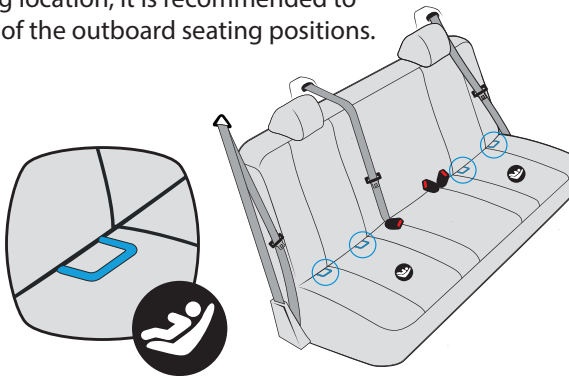

## VEHICLE SEAT BELT TYPES

The following types of vehicle belts **CANNOT BE USED** with your child restraint.

If any of the belt types listed below are in the chosen seating position, you **MUST** choose another seating position or use LATCH/UAS if available.

1. Motorized (Automatic) Vehicle Belts
2. Dual Retractor Lap/Shoulder Belts
3. Non-Locking (ELR) Lap Belts
4. Inflatable Seat Belts
5. Door Mounted Vehicle Belts

*Please refer to your vehicle owner's manual for specific information about seat belts and their use with child restraints.*

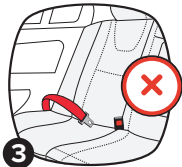
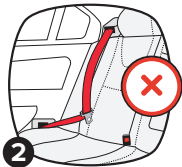
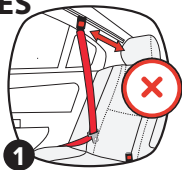



# VEHICLE SEAT BELT TYPES

## TYPES OF SEAT BELT LATCH PLATES SAFE TO USE WHILE SECURING YOUR CAR SEAT

### 1. Lap Belt with Locking Latch Plate.

Once buckled, the vehicle belt is tightened by pulling on the free end of the strap until the belt is tight.

**TIP:** A way to tell if the seat lap belt is a locking latch plate is to sit in the vehicle and buckle yourself in. Pull gently on the lap belt. If it stays tight, it is locking.

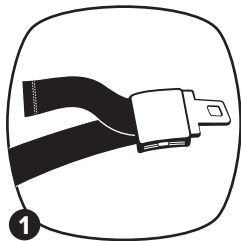

### 2. Lap Belt with Automatic Locking Retractor (ALR).

The automatic locking retractor does not allow the lap belt to get longer once it is buckled and retractor is locked.

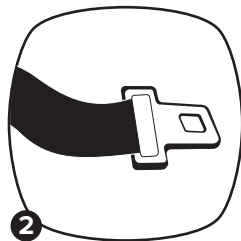

The vehicle belt is tightened by feeding seat belt webbing into retractor after it has been locked.

## VEHICLE SEAT BELT TYPES

- 3. Lap/Shoulder Belt with Locking Latch Plate.** The lap portion of this belt does not loosen once the belt is buckled.

The vehicle belt is tightened by pulling up hard on shoulder belt and feeding the extra webbing into the retractor.

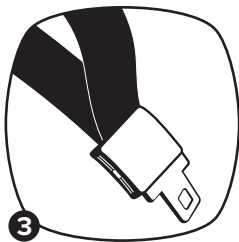

- 4. Lap/Shoulder Belt with Sliding Latch Plate with Locking Retractor.** The latch plate slides freely along the lap/shoulder belt.

Vehicle belts with sliding latch plates are typically locked at the shoulder belt retractor by pulling all of the webbing out slowly until it stops to switch the retractor. (see page 28)

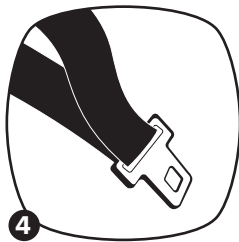

**DO NOT** use **Non-Locking Latch Plates** to secure your car seat. Types of non-locking latch plates are:

- Sliding Latch Plate with an Emergency Locking Retractor.
- Dynamic Latch Plate
- Sewn-On Latch Plate

# VEHICLE SEAT BELT TYPES

*Please refer to your vehicle owner's manual for further information on which type of **LATCH PLATES** are located in your vehicle.*

**NOTE:** LATCH/UAS can be used **IN PLACE** of these vehicle belt types. Refer to your vehicle owner's manual for LATCH/UAS locations.

## TYPES OF RETRACTORS

### 1. Emergency Locking Retractors (ELR)

- Only locks with sudden stops, accelerations, turns or if involved in an accident.
- For **Rear-Facing** and **Forward-Facing** installations you **MUST** use LATCH/UAS or a locking clip if your vehicle is only equipped with ELR retractors.

### 2. Automatic Locking Retractor (ALR)

- Found in older vehicles and **MUST** be used to secure your child in **Rear-Facing** and **Forward-Facing** installations only.

# VEHICLE SEAT BELT TYPES

## 3. Switchable Retractor

Most common type of retractor and is switchable from (ELR) to (ALR).

- **MUST** switch to (ALR) mode for **Rear-Facing** and **Forward-Facing** installations only.
- Leave in (ELR) mode for **Booster** use only.

### HOW TO SWITCH YOUR SWITCHABLE RETRACTOR FROM (ELR) TO (ALR) MODE

1. Feed latch plate into the proper belt path. Be sure the belt is flat and not twisted.
2. Click the latch plate into the vehicles buckle.
3. Locate the retractor then gently pull the seat belt out of the retractor until it stops, then slowly feed webbing back into retractor.

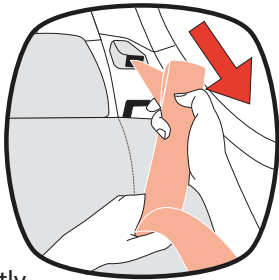

**IMPORTANT:** You will hear clicking. This is how you know you have locked the retractor.

# VEHICLE SEAT BELT TYPES

## 4. No Retractor

Some older vehicles do not have a retractor to store the excess seat belt webbing, leaving the excess webbing visible.

**Lap belts without a retractor will always have a latch plate that provides the locking feature necessary to secure your car seat properly.**

*Review your vehicle owner's manual for specific instructions on what type of seat belt system your vehicle is equipped with.*

# LATCH/UAS

## WHAT IS LATCH/UAS?

Most vehicles manufactured after September 1, 2002 are equipped with:



**U.S.: LATCH** (Lower Anchors and Tethers for CHildren)

**Canada: UAS** (Universal Anchorage System)

Check your vehicle owner's manual to determine LATCH/UAS lower anchor compatible seating positions. Some vehicle manuals use the term "ISOFIX" instead; LATCH/UAS can also be used in vehicle seating positions that are equipped with ISOFIX. Look for the LATCH/UAS symbol that may be visible by the crease of the rear seats.

**WARNING: DO NOT** use the LATCH/UAS strap to attach this child restraint **Rear-Facing** when restraining a child weighing over 35 lb (15.8 kg) or **forward-facing** when restraining a child weighing over 40 lb (18 kg).

**DO NOT** install using both LATCH/UAS connectors and the vehicle seat belt at the same time.

# SIDE IMPACT MANAGEMENT

Your car seat includes a Side Impact Management (SIM) Pod that will provide additional side impact protection.

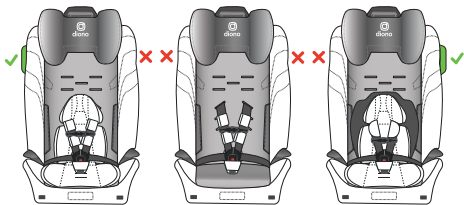

1. Place your SIM pod on the side of the car seat adjacent to the vehicle door.
2. Insert the front hook into the slot on the side of the seat.
3. Insert the back hooks into the slots on the back of the seat. An audible "click" should be heard when attached to the slots correctly.



***To remove the SIM pod, lift the pod tab release from the back of the seat, then gently remove the front hook from the side of the seat.***



# FIRST SETUP

## A. UNFOLDING CAR SEAT

1. Place car seat on its back on a flat surface and unfasten red carry strap from the bottom. Be sure the harness adjuster strap moves freely and is not locked within the bottom of the seat. Remove cup holder if present.

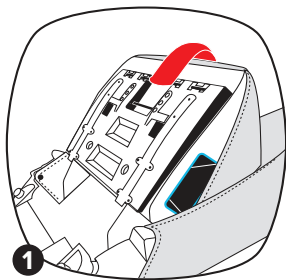

2. Rotate bottom **OPEN** until you hear it “click”. This confirms the car seat is locked for use.

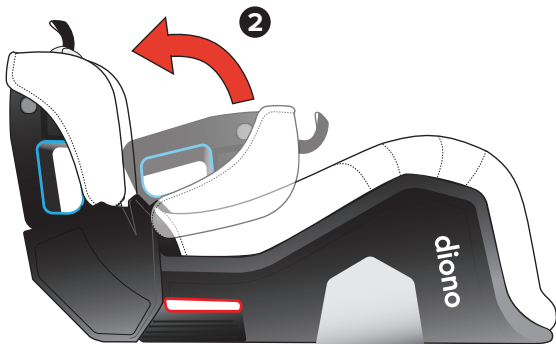



## FIRST SETUP

3. Pull harness adjusting strap until harness begins to tighten. If it does not tighten freely, check the belt path on the back of the seat bottom is clear from obstruction.
4. Fasten both of the fabric side panels on the inside of the cover.
5. Tuck the red strap through the center slot between the upper harness slots.

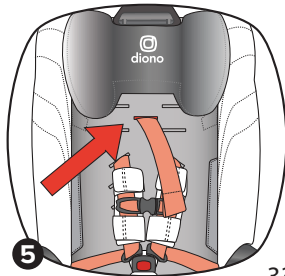
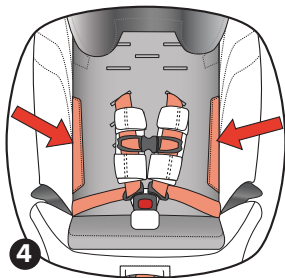
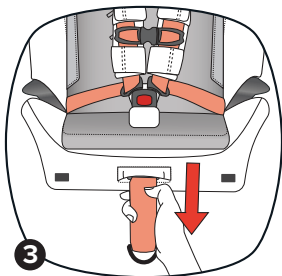

**IMPORTANT:** Before securing your child make sure the car seat is locked in the open position. If not, repeat instructions from step one.

## FIRST SETUP

**IMPORTANT!** Setup harness before installing car seat in vehicle.

### B. HARNESS STRAP PLACEMENT

**Rear-Facing:** Harness straps **MUST** be at or just below the child's shoulders. Top of head must be 1.5 in (3.8 cm) below the top of the car seat shell.

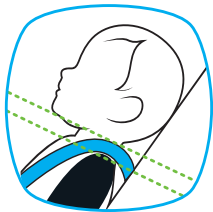

**Forward-Facing:** Harness straps **MUST** be above the child's shoulders. Top of child's ears **MUST** be below top of car seat shell.



### C. BUCKLE SLOT PLACEMENT

**Rear-Facing:** Any of three buckle positions are acceptable, as long as the harness is snug on the child's shoulders and child is not sitting directly on top of center buckle.

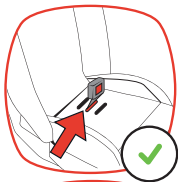

**Forward-Facing:**

- **22–30 lb (10–13.6 kg) MUST** use the middle buckle slot **ONLY!**
- Above **30 lb (13.6 kg) MUST** use the forward most buckle slot **ONLY!**



# FIRST SETUP

## D. CHANGING HARNESS POSITON

1. Unbuckle the chest clip and harness buckle.
2. To loosen harness, push down on silver lever and pull shoulder straps forward.
3. Detach harness straps from metal plate on back of seat.
4. Pull each harness through to the front of the seat.
5. Re-locate each harness to the correct slot determined. Then push through to the back of the seat taking care to keep each harness strap flat.
6. Re-secure the harness straps to the metal plate. Make sure to secure the left strap onto the metal hook first then secure the second strap onto the metal hook.

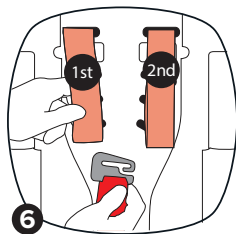
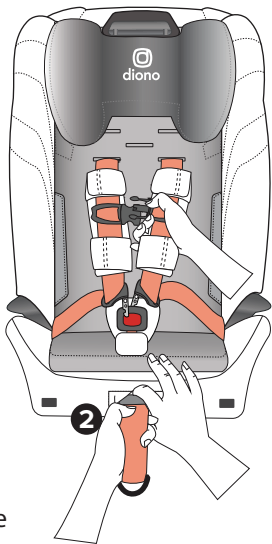

# FIRST SETUP

## E. BUCKLE STRAP SLOT CHANGE

### Buckle Strap Removal

1. Look through the **rear-facing** belt path for a better view of the buckle strap metal retainer.
2. To create slack, locate buckle and push buckle strap into the bottom of the car seat base.
3. Partially fold seat (*see pg 84*).
4. Reach into the bottom of the seat. You will feel the buckle strap metal retainer.

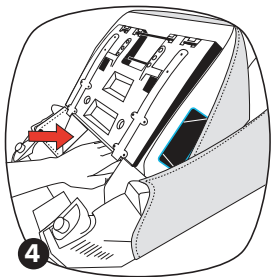
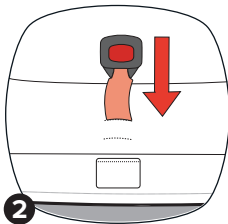
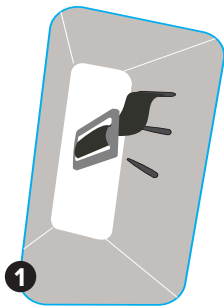

## FIRST SETUP

5. Rotate metal retainer vertical and insert it up through the shell and pad. From the top of the car seat, pull the buckle strap out.

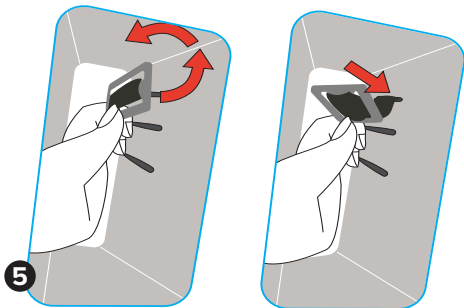

### Buckle Strap Insert

1. Find appropriate buckle slot.
2. Make sure the red release button faces towards the front of the car seat and the buckle strap is not twisted.
3. Hold metal retainer vertical and firmly push through appropriate slot and all the way through the bottom of the seat.
4. Pull up on buckle strap to confirm buckle is secured.

# FIRST SETUP

## F. HARNESS TIGHTENING

*Prior to installing the car seat into your vehicle, follow these steps to set up harness.*

- 1.** To loosen harness push down on silver harness release and pull shoulder straps forward.
- 2.** Unfasten chest clip and harness buckle, and move harness straps to the sides.
- 3.** Properly position child in car seat, all the way back and sitting upright.
- 4.** Position harness straps around the child and fasten buckle with harness pad positioned between the buckle and the child. Gently tug on harness strap to make sure straps are securly buckled.

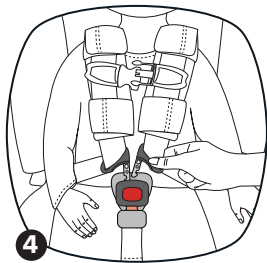
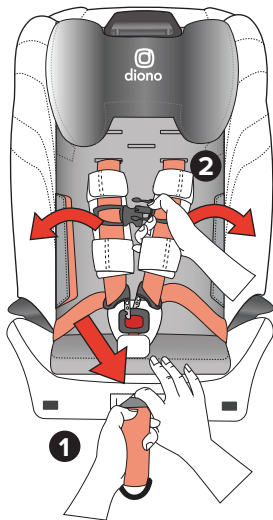

## FIRST SETUP

5. Gently pull harness straps upwards to snugly fit lap portion of harness across the body and low on the child's hips.
6. Slowly pull harness adjuster strap downwards (**forward-facing**) or straight up (**rear-facing**), using a pull-tug motion, to tighten harness for a comfortable and snug fit around child.

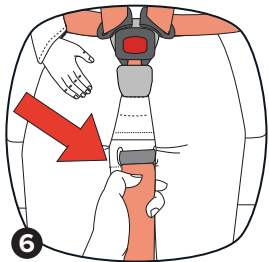

7. Confirm harness is not twisted and lays flat against child's chest.
8. Properly position harness chest clip level with child's armpits then fasten chest clip together.

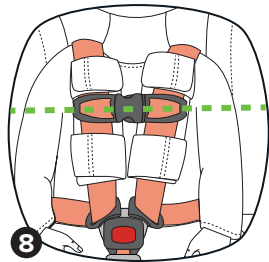

Continued on the next page.

## FIRST SETUP

9. Finally, do the **PINCH TEST**. Take the thumb and index finger and 'glide' your fingers along the harness at the collar bone. If you are able to pinch any of the webbing of the harness strap, tighten it again. If you can't pinch the harness then it's properly tightened.

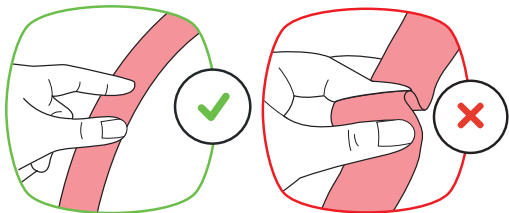

**NOTE:** If harness pads are used, you may need to unfasten the top harness pad to access strap to successfully administer the pinch test.

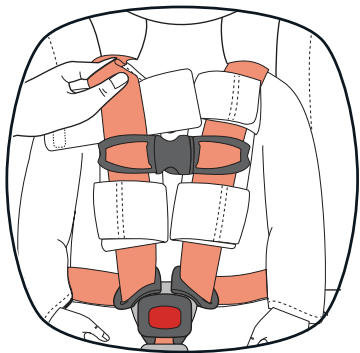



# FIRST SETUP

## G. ADJUSTING HEADREST

1. Press lever on headrest and slide up or down to adjust.
2. Listen for audible "click" to confirm headrest is in locked position.

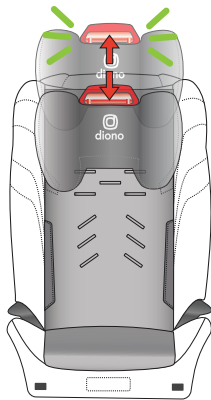

### IMPORTANT!

- A. When using the bottom harness slot, position headrest level with the top of the seat.
- B. When using the top 4 harness slots, position headrest so that the bottom edge is above the shoulders and about level with the jaw.

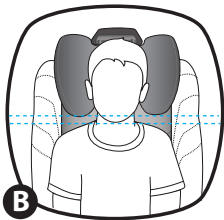
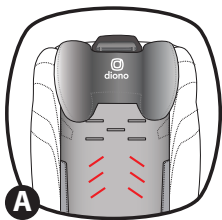

## REAR-FACING

### REAR-FACING

Installation Instructions

4–50 lb (1.8–22.7 kg)

18–44 in (46–112 cm)



LATCH/UAS Strap



Vehicle **Lap/Shoulder** Belt



Vehicle **Lap** Belt

## REAR-FACING

**Infants who weigh less than 22 lb (10 kg) and are under one year old, MUST use this car seat rear-facing.**

- **MUST** attach rear-facing base to car seat.
- Install this car seat tightly in your vehicle. When checked at the rear-facing belt path, the car seat should not move more than 1 in (2.5 cm) from side-to-side or front-to-back. If using a lap belt only, refer to your vehicle owner's manual for installation advice.
- Harness straps **MUST** be at or just below the top of your child's shoulders. Place the chest clip at armpit level.

The American Academy of Pediatrics (AAP), NHTSA and Diono **RECOMMEND** that children be rear-facing until two years of age or they reach the maximum rear-facing height or weight of their car seat. This car seat can remain rear-facing up to 50 lb (22.7 kg) or 44 in (112 cm) tall.

## REAR-FACING

### DETACHABLE REAR-FACING BASE INSTRUCTIONS

**ONLY** use rear-facing base on **rear-facing** installs.

1. Confirm car seat is locked in its unfolded position.
2. Insert hooks into the aligned slots and rotate the base until hearing an audible “click”.

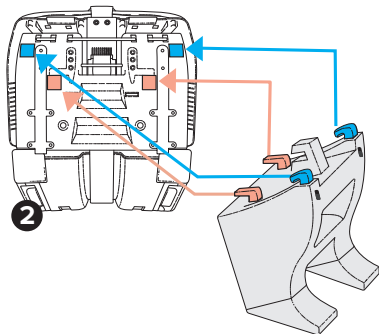

**Confirm base is locked and does not move.**

*To remove, press release buttons and pull top end outwards to remove top section. Gently detach base lower hooks from seat bottom.*

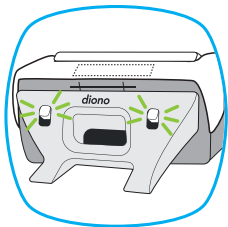

## REAR-FACING

### SEAT BIGHTS

#### Non-Elevated Seat Bight

Place the car seat on the vehicle seat making sure the feet of the rear-facing base are securely tucked in the seat bight and flat on the vehicle seat bottom. The front of the car seat will also be touching the vehicle seat back.

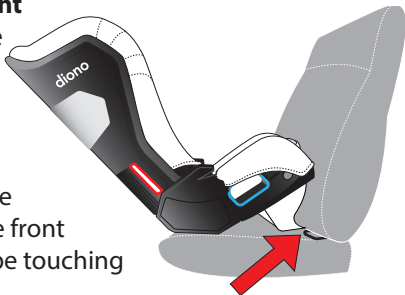

#### Elevated Seat Bight

For vehicles with an elevated seat bight, make sure the feet of the rear-facing base are flat on the vehicle seat bottom. With an elevated seat bight it is acceptable if the front of the car seat does not touch the vehicle seat back.



**DO NOT** push the feet of the rear-facing base into the elevated seat bight as this will change the recline angle.

## REAR-FACING

### ANTI-REBOUND PANEL (ARP)

Diono **RECOMMENDS** using the anti rebound panel (ARP) with rear-facing installs.

1. Place the ARP into the slots on the front of the car seat until hearing an audible "click". Pull bars outwards to confirm it is locked.
2. Push the buttons on the outside hinge of the ARP and rotate the board up until hearing an audible "click". Pull on ARP to confirm it is locked into position.

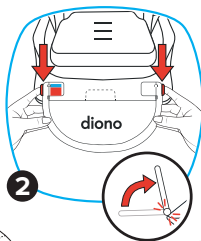
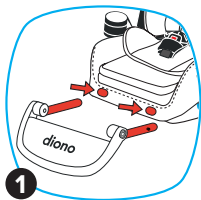

**IMPORTANT:** DO NOT use the ARP in any other configuration than noted for rear-facing installations.

**To remove, press the release buttons on the outside of the seat and pull the ARP out.**

**NOTE:** You may need to release one side at a time.



## REAR-FACING

### INFANT SUPPORT

To ensure a better fit for smaller infants, we recommend using the infant head and body support cushions included with your car seat. The infant support also includes a removable Travel High Wedge for better positioning of infants. Use of these cushions and wedge is optional and does not affect the safety of the seat.



To use, slide the buckle through the buckle slot on the infant body cushion that matches the slot chosen on the seat then adjust harness.

### NEWBORN HARNESS PADS (OPTIONAL)

These harness pads were developed specifically for smaller infants and newborns. Use these in place of the standard harness pads.

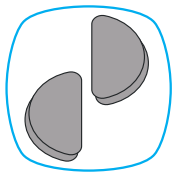

Replace newborn harness pads with standard harness pads when the child becomes tall enough to need additional padding on seat harness.

## REAR-FACING

### NEWBORN PROTECTION INSERT

4–10 lb (1.8–4.5 kg)

The newborn protection insert is used in combination with the infant support cushion to provide side protection in the event of a collision.

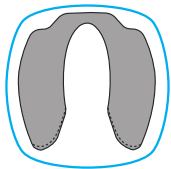

Install infant support by sliding the buckle through the buckle slot on the cushion that matches the slot chosen on the seat (*see pg 34*) then slide newborn protection insert behind infant support cushion.

**DO NOT** use newborn protection insert **WITHOUT** the infant support cushion.

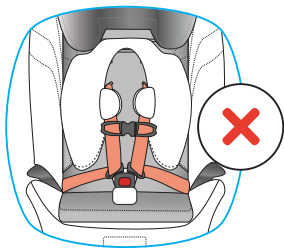



## REAR-FACING

### INSTALL USING:



#### LATCH/UAS

4–35 lb (1.8–15.8 kg)

**DO NOT** install by this method for a child weighing more than 35 lb (15.8 kg). Reinstall with vehicle seat belt for a child weighing between 35–50 lb (15.8–22.7 kg).

1. Install detachable rear-facing base (see pg 44) and ARP (see pg 46).
2. Remove LATCH/UAS strap from storage location on back of seat. Use LATCH/UAS red release tabs on LATCH/UAS connectors and pull up to remove.

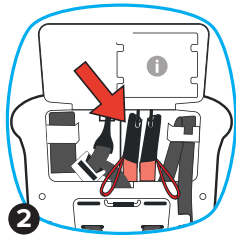

## REAR-FACING

### 3. Extend the LATCH/UAS strap.

For easier installation, extend the LATCH/UAS strap to its maximum length by pressing the grey button and pulling on the strap.

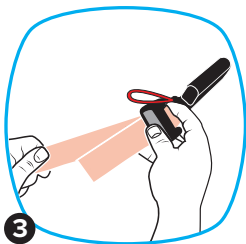

### 4. Place car seat rear-facing in back seat of the vehicle with detachable rear-facing base and ARP installed.

Center the car seat between the vehicle LATCH/UAS anchors. The seat bottom and feet of the rear-facing base should sit flat on the vehicle seat with no overhang.



### 5. Slide the LATCH/UAS strap through the rear-facing belt path and out the other side.

The LATCH strap should lie flat and not be twisted. The red release loops on the connectors should be facing up and tightening mechanism should be on the child's left side of seat.

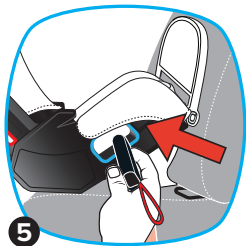

## REAR-FACING

6. **Attach LATCH/UAS connectors to vehicle LATCH/UAS anchors and listen for audible "click" to confirm engagement.**

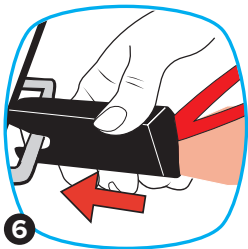

7. **Tighten the LATCH/UAS strap.** With one hand press down firmly in the center of the car seat while tightening the LATCH/UAS strap with the other hand. You may need to tighten further by pulling upwards in-line with the belt path.



8. **Test for tightness.** Grab the seat at the bottom of the rear-facing belt path. Try to move the car seat side-to-side and front-to-back with the force of a firm handshake. If the seat moves less than 1 in (2.5 cm), it is tight enough. **DO NOT test by grasping the top or back of the car seat. Only check by grabbing at the rear-facing belt path opening.**

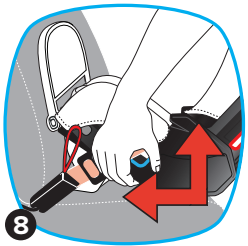

## REAR-FACING

9. To remove **LATCH/UAS strap from vehicle** use the LATCH/UAS red release straps on the LATCH/UAS connectors and pull them off the anchor bars.

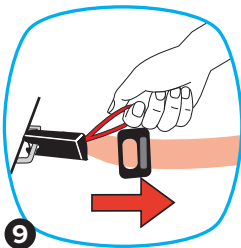

## REAR-FACING

### INSTALLATION WITH:



**LAP/SHOULDER BELT**  
4–50 lb (1.8–22.7 kg)



**LAP BELT**  
4–50 lb (1.8–22.7 kg)

1. **Install detachable rear-facing base (see pg 44) and ARP (see pg 46).**
2. **Place car seat rear-facing in back seat of the vehicle with detachable rear-facing base and ARP installed.** Center the car seat on the vehicle seat. The seat bottom and feet of the rear-facing base should sit flat on the vehicle seat with no overhang.



## REAR-FACING

3. **Slide the vehicle seat belt through the rear-facing belt path and out the other side.** Buckle it. Confirm the seat belt is flat and not twisted.



4. **Tighten the belt strap,**

A. **LAP/SHOULDER BELT**

**Switch your the vehicle seat belt to ALR mode (see pg 28)** Once the retractor is locked press down firmly in the center of the seat while pulling on the shoulder belt nearest to the buckle. Keep tension on the shoulder belt while feeding the slack back into the retractor.

OR

B. **LAP BELT**

To tighten, press down firmly in the center of the car seat with one hand while tightening the lap belt strap with the other hand. You may need to tighten further by pulling in-line with the belt path.



## REAR-FACING

5. **Test for tightness.** Grab the seat at the bottom of the rear-facing belt path. Try to move the car seat side-to-side and front-to-back with the force of a firm handshake. If the seat moves less than 1 in (2.5 cm), it is tight enough. **DO NOT test by grasping the top or back of the car seat. Only check by grabbing rear-facing belt path opening.**



## FORWARD-FACING

# FORWARD-FACING

Installation instructions

22–65 lb (10–29.5 kg)

30–57 in (76–145 cm)

# 2

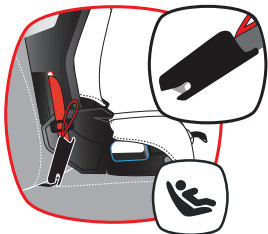

LATCH/UAS Strap

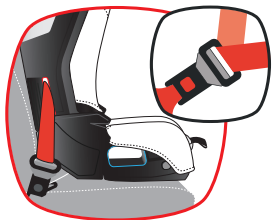

Vehicle **Lap/Shoulder** Belt

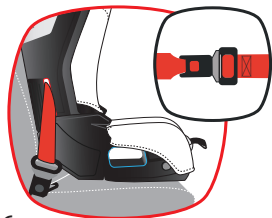

Vehicle **Lap** Belt



## FORWARD-FACING

The **American Academy of Pediatrics (AAP)**, **NHTSA** and **Diono** recommend that children be rear-facing until they reach the maximum rear-facing height or weight. This car seat can remain rear-facing up to 50 lb (22.7 kg).

- When checked at forward-facing belt path, this car seat should not move more than 1 in (2.5 cm) from side-to-side or front-to-back. If using a lap belt only, refer to your vehicle owners manual for installation advice.
- Harness straps **MUST** be above the top of your child's shoulders. Place chest clip at armpit level.
- In forward-facing mode, the top of the car seat **MUST** be supported by either the vehicle's head support or the vehicle's seat back.
- A gap between the car seat and the vehicle's seat back is acceptable as long as the top is supported and the bottom is flat on the vehicle's seat.
- While using **ONLY** the lap belt, you must use the 5th harness slot with the lap belt cushion.

## FORWARD-FACING

### TOP TETHER

**ALWAYS** Use the top tether.

A tether is designed to reduce movement of a forward-facing child restraint in a collision.

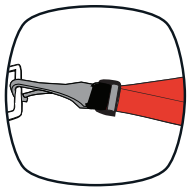

Vehicle tether anchors can be found in many locations within the vehicle. Some of the typical locations are shown here. Please refer to your vehicle owner's manual for exact locations, requirements, and anchor identification points.

### FORWARD-FACING TOP TETHER INSTALLATION

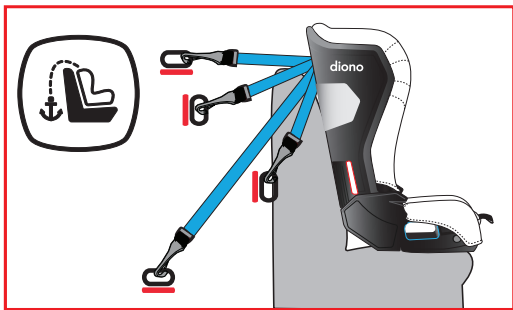

# FORWARD-FACING

## SAFE STOP

Safe Stop is for use **ONLY** in forward-facing installations with children weighing 22–40 lb (10–18 kg).

**DO NOT** use rear-facing. **DO NOT** use in booster mode.

**IMPORTANT:** The Safe Stop will need to be removed once the child reaches 40 lb (18 kg).

1. **Locate Safe Stop.**
2. **Remove harness straps from metal plate.** Detach harness from metal plate on back of seat. Once detached, thread both harness straps onto the metal hook of the Safe Stop. Connect left side of harness first, then follow with the right.
3. **Thread bottom of Safe Stop onto the harness strap hook.** Check to ensure proper engagement to the metal plate. Take care to ensure harness straps are not twisted and are clear from any obstructions.

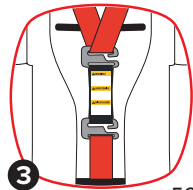
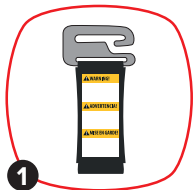

# FORWARD-FACING

## ADJUSTABLE BOTTOM

**WARNING!** Use adjustable bottom for **forward-facing** installs only.

**DO NOT** use **rear-facing**. **DO NOT** use in **booster mode**.

**IMPORTANT:** If the child is **OVER 25 LB (11.3 KG)**, lower the adjustable bottom.

1. Lift the bottom bar up and grasp the upper bar toward the seat bottom to release.
2. Pull bar towards you to extend the adjustable bottom. Listen for audible “click” to confirm bottom is in locked position.

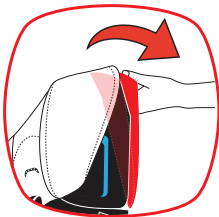
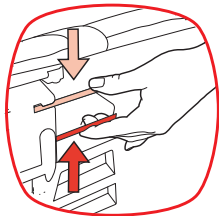

***To store adjustable bottom, lift the lower bar up while grasping the top bar and push the bottom back into the seat base.***

# FORWARD-FACING

## ANTI-REBOUND PANEL (ARP)

**NOTE:** Anti rebound panel is for comfort only. It is not required for forward-facing installs.

1. Place the ARP into the slots on the front of the car seat until hearing an audible "click". Pull bars outwards to confirm lock in place.
2. Push the buttons on the outside hinge of the ARP in and rotate the board down until hearing an audible "click" at the desired angle. Push on board to confirm it is locked into position.

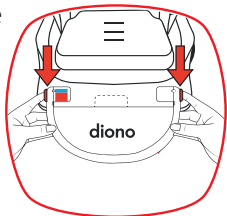
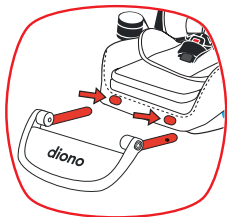

**DO NOT** use ARP in rear-facing position when installed forward-facing.

**To remove, press the release buttons on the outside of the seat and pull the ARP out.** **NOTE:** You may need to release one side at a time.



## FORWARD-FACING

### 80/20 OVERHANG GUIDANCE

**IMPORTANT:** To follow 80/20 overhang guidance, ensure that no more than 20% of the car seat base overhangs beyond the front edge of the vehicle seat cushion.

#### ESTIMATING METHOD

1. Estimate the halfway point of the car seat base.
2. Then halve the outer half (the half farthest from the seat bight) to mark the spot that would be about 75%.
3. Add a bit more to the footprint that is supported by the seat cushion. This will be around 80% and that would be meeting the 80/20 overhang guidance.

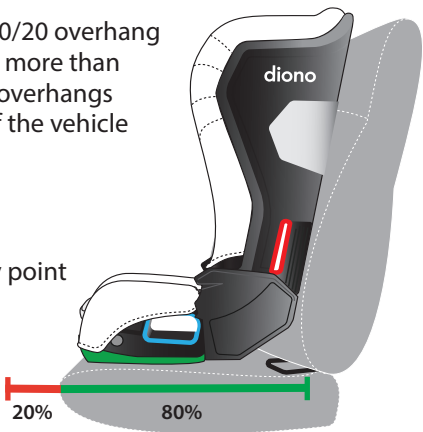

**If results are unclear using the estimating method, use a tape measure and do the math.**

## FORWARD-FACING

### INSTALL USING:



**LATCH/UAS**  
**22–40 lb (10–18 kg)**

**DO NOT** install by this method for a child weighing **more than 40 lb (18 kg)**. Reinstall with lap/shoulder belt for weights between 40–65 lb (18–29.5 kg).

- 1. Remove LATCH/UAS strap from storage location on back of seat.** Use LATCH/UAS release on the LATCH /UAS connectors to remove.

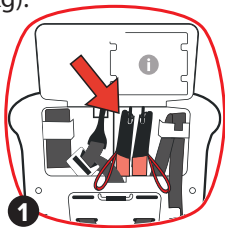

- 2. Extend the LATCH/UAS strap.** For easier installation, extend the LATCH/UAS strap to its maximum length by pressing the grey button and pulling on the strap.

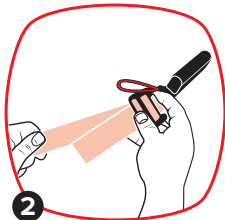

Continued on the next page

## FORWARD-FACING

- Unhook and remove top tether strap from storage location on the back of seat.**
- Feed LATCH/UAS connectors into forward-facing belt path.** The LATCH/UAS connectors are easier to feed through by opening side panels and routing behind cover. The LATCH/UAS connectors are easier to feed through by opening side panels and routing behind cover. The red release loops on the connectors should be facing up and tightening mechanism should be on the child's left side of seat.

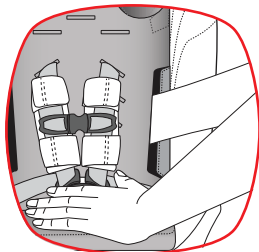
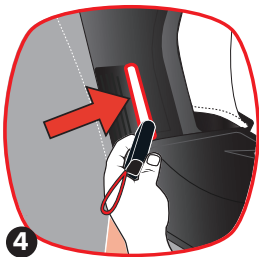
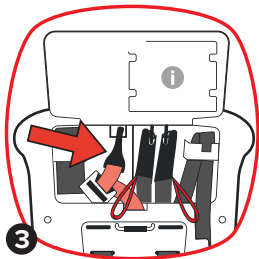
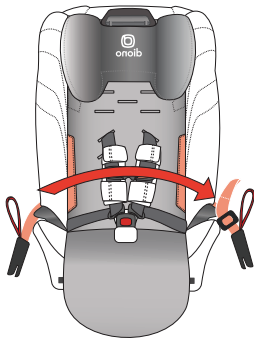



## FORWARD-FACING

5. **Place car seat forward-facing in back seat of the vehicle.** Center the car seat between the vehicle LATCH/UAS anchors. The entire seat bottom should sit flat on the vehicle seat. If overhang is present refer to page 62.



6. **Loosely attach tether strap.** Do not tighten. *Consult your vehicle owners manual for specific tether anchor locations.*

7. **Attach LATCH/UAS connectors to vehicle's LATCH/UAS anchors and listen for audible "click" to confirm engagement.** LATCH/UAS strap should lie flat and not be twisted.



Continued on the next page

## FORWARD-FACING

8. **Tighten the LATCH/UAS strap.** Press down firmly in the center of the car seat while tightening the LATCH/UAS strap. Tighten by pulling the adjuster strap through the opening in the cover.

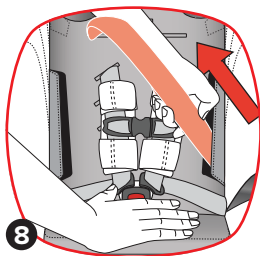

9. **Test for tightness.** Grab the seat at the **forward-facing** belt path. Try to move the car seat side-to-side and front-to-back with the force of a firm handshake. If the seat moves less than 1 in (2.5 cm), it is tight enough. **DO NOT test by grasping the top or back of the car seat. Only check by grabbing forward-facing belt path opening.**

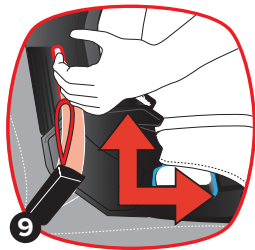

## FORWARD-FACING

- 10.** Tighten the top tether strap to remove the slack. There should not be any extra tension on the top tether. **Do not** push on the car seat back while tightening. Compressing the car seat into the vehicle seat might result in a top tether that is too tight.

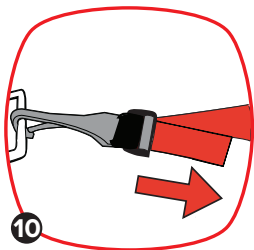

- 11. To remove LATCH/UAS strap from vehicle** use the LATCH/UAS red release straps on the LATCH/UAS connectors and pull them off the anchor bars.

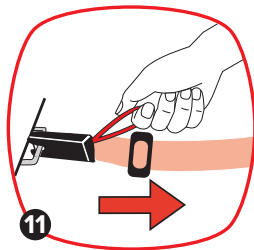

- 12. To loosen or remove the top tether,** push in on the grey button to loosen, then unclip the top tether.

## FORWARD-FACING

### INSTALL USING:



**LAP/SHOULDER BELT**  
22–65 lb (10–29.5 kg)



**LAP BELT**  
22–65 lb (10–29.5 kg)

1. Unhook and remove top tether from storage location on back of seat.
2. Place car seat **forward-facing** in back seat of the vehicle. The entire seat bottom should sit as flat as possible on the vehicle seat. If overhang is present refer to page 62.

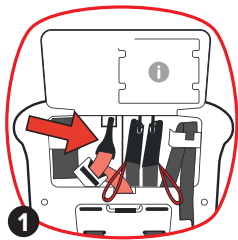

## FORWARD-FACING

- Loosely attach top tether strap. Do not tighten. **Consult your vehicle owner's manual for specific location.**
- Unfasten fabric side panels and reach behind cover for easy access to belt path.
- Slide the vehicle seat belt through the **forward-facing** belt path and out the other side. Buckle it. The seat belt should lie as flat as possible and not be twisted.

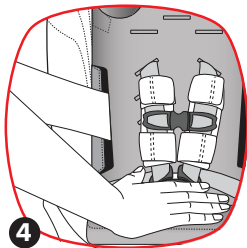
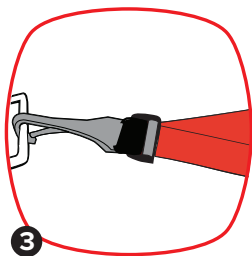

## FORWARD-FACING

### 6. Tighten the belt strap,

#### A. **LAP/SHOULDER BELT**

##### **Lock your seat belt**

**retractor (see pg 28)** Once the retractor is locked, press down firmly in the center of the seat while pulling on the lap/shoulder belt nearest to the buckle. Keep tension on the lap/shoulder belt while feeding the slack back into the retractor.

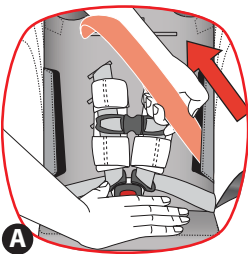

OR

#### B. **LAP BELT**

To tighten, press down firmly in the center of the car seat with one hand while tightening the lap belt strap with the other hand. You may need to tighten further by pulling in-line with the belt path.

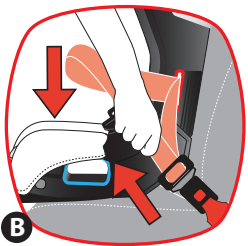

## FORWARD-FACING

7. Tighten the top tether strap to remove all the slack. There should not any extra tension on the top tether. **Do not** push on the car seat back while tightening. Compressing the car seat into the vehicle seat might result in a top teather that is too tight.

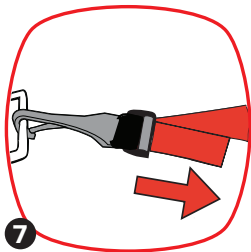

8. **Test for tightness.** Grab the seat at the **forward-facing** belt path. Try to move the car seat side-to-side and front-to-back with the force of a firm handshake. If the seat moves less than 1 in (2.5 cm), it is tight enough. **DO NOT test by grasping the top or back of the car seat. Only check by grabbing forward-facing belt path opening.**



## FORWARD-FACING

### LAP BELT CUSHION

**\*- IMPORTANT! FOR FORWARD-FACING INSTALLATIONS USING A LAP BELT ONLY WITH NO TOP TETHER ANCHOR AVAILABLE FROM 22–65 LB (10–29.5 KG). DO NOT USE REAR-FACING. -\***

**\*-MUST USE 5TH HARNESS SLOT.-\***

- 1. Remove the center buckle pad** by pulling it carefully up and over the buckle.
- 2. Unclip seat cover from seat bottom.** Lift seat cover away from the seat bottom and remove the buckle.
- 3. Place lap belt cushion on seat bottom, and slide the buckle through the slot in the cushion** that matches the slot position being used on the seat.

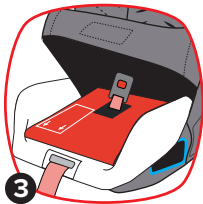
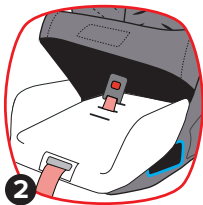
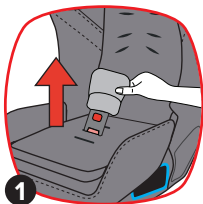



## FORWARD-FACING

4. Guide buckle through seat cover bottom and memory foam cushion. Reattach cover to seat bottom.
5. Reinstall the center buckle pad. ***Should you need a longer buckle, these are available by calling customer care.***

## BOOSTER

### BOOSTER MODE

Installation instructions

**40–120 lb (18–54 kg)**

**40-57 in (101-145 cm)**

**ALWAYS** use **ONLY** the vehicle lap/shoulder belt system when restraining the child in this booster seat.

- **DO NOT** use a lap belt only!
- **DO NOT** use with detachable base.
- **DO NOT** use with adjustable bottom lowered.
- **DO NOT** use if the child's shoulders are not at or above the 4th harness slot.

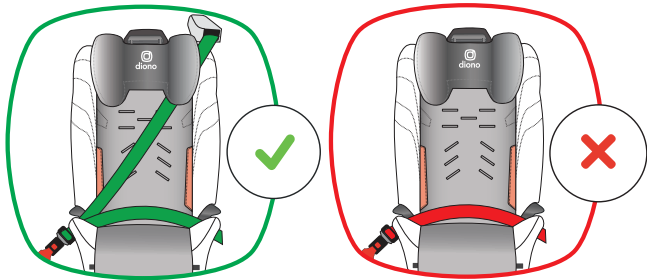

## BOOSTER

**ALWAYS** secure the child restraint when it is unoccupied using the vehicle lap/shoulder belt or LATCH/UAS connectors. It could injure other occupants in a sudden stop or collision.

1. Remove the 5-Point harness (*see pg 82*).
2. Place child in car seat with their back flat against the back of the seat. The entire seat bottom should sit as flat as possible on the vehicle seat. If overhang is present refer to page 62.
3. Adjust head support to proper height. The bottom of the headrest should be even with the child's jaw. Squeeze the head support adjustment lever on the back of the booster seat to adjust it's height up or down to fit the child.

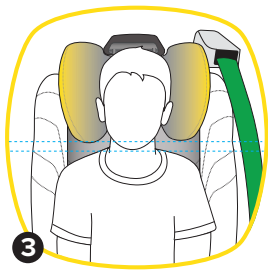

Continued on the next page

## BOOSTER

4. Feed the shoulder belt through the upper belt guide and over booster seat.

**IMPORTANT!** When the shoulder belt is routed through the upper belt guide, pull some webbing out of the retractor. Slowly release it to make sure the belt properly feeds back into the retractor. **Do this between each use.**

If the belt does not retract properly, you must choose another seating position or continue to use the seat in harness mode if the child is still within the forward-facing height or weight limits.

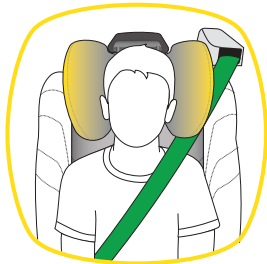

## BOOSTER

5. Buckle the vehicle seat belt making sure the lap portion of the belt goes under both lower belt guides and lays across your child's hips. **DO NOT** lay belt high over the child's belly.



Be sure the shoulder belt lays across your child's shoulders, between the neck and edge of the shoulder. The shoulder belt should **NOT** hover over the shoulder or touch the child's neck.

Make sure shoulder belt is under the lower belt guide and closest to the buckle.

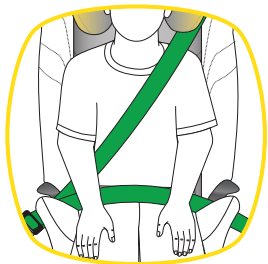

## AIRCRAFT INSTALLATION

1. Adjust the seat belt buckle to its shortest length to ensure the buckle is not in the belt path and accessible for release.
2. Ask the flight attendant for a “seat belt extender” and then use this extender to adjust the seat belt length.
3. Following the instructions for the lap belt installation for rear-facing (*see pg 53*) and for forward-facing (*see pg 68*).



**THIS RESTRAINT IS NOT CERTIFIED FOR USE IN AIRCRAFT IN BOOSTER MODE.** Aircraft seats do not have shoulder belts which are required for booster mode with this child restraint.

# COMFORT FEATURES

## CUP HOLDER

1. To attach your cup holder, locate the cup holder icon on seat cover on either side of the seat.
2. Insert the cup holder into the slot in the seat. Push down to securely engage the cup holder into the slot and twist to secure.



**CAUTION: DO NOT** use with hot liquids as this could burn a child.

## EXPANDABLE SIDE WINGS

The side wings can be adjusted for comfort. These will not impact the safety of the car seat in any manner. Simply push the side wings outward as shown to extend.

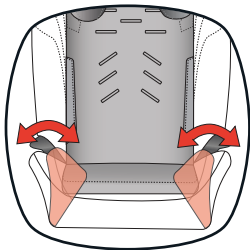

# COMFORT FEATURES

## TODDLER LINER

A seat liner for toddlers is provided for comfort and does not affect the safety of the seat.

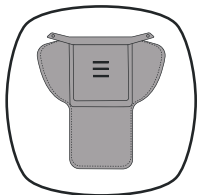

**DO NOT** use in rear-facing installations.

**DO NOT** use with infant support cushion and/or newborn protection insert.

**ALWAYS** secure toddler liner to seat cover with snaps.

### Forward-Facing Installation:

1. Unbuckle harness and remove buckle pad.
2. Insert memory foam cushion into toddler liner.
3. Thread the buckle through the slot appropriate for the weight of your child and replace buckle pad (if needed).
4. Fasten snaps to back side of cover behind harness slots.

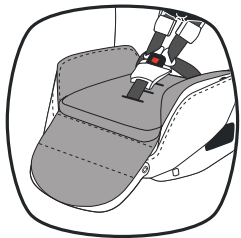



## COMFORT FEATURES

### Booster Installation:

1. Remove harness (see pg 80)
2. Insert memory foam cushion into toddler liner.
3. Fasten snaps to back side of cover behind harness slots.

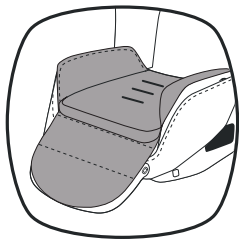

# HARNES STRAP REMOVAL

**HINT:** Before removal have your phone handy and take photos of the process for future reference.

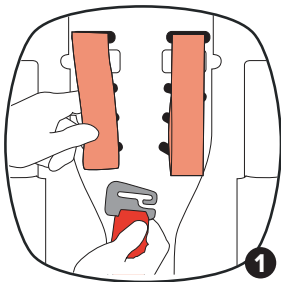

1. Remove harness straps from the metal hook on back of seat.
2. From the front of the seat pull the harness straps through and out of the harness slots. Remove the harness pads and chest clip from each side.



3. Using a standard screwdriver, locate the notches in the harness access panel near the lower belt guides and pull the panel away from the seat shell. Remove old harness straps from each side of the seat.

## HARNESS STRAP REMOVAL

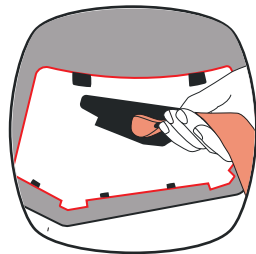
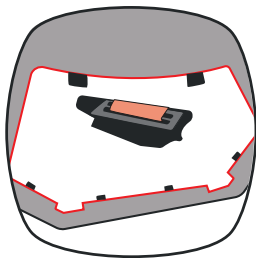
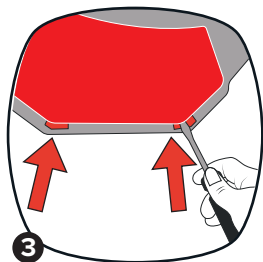

# HARNESS STRAP REPLACEMENT

**HINT:** Before replacement of harness strap have your phone handy and take photos of the process for future reference.

1. Insert new harness strap through the harness panel slot and pull the strap up.
2. Once the strap is pulled up until the metal “D” ring is located as shown, re-fasten and close the access panel by pushing onto slot until an audible “click” is heard.



## HARNES STRAP REPLACEMENT

3. Slide the new harness straps through the buckle tongues in the center buckle, re-attach the chest clip and reinstall the harness pads. Making sure the harness straps are oriented correctly and not twisted.



4. Re-secure the harness straps to the metal plate. Make sure to secure the left strap onto the metal hook first then secure the second strap onto the metal hook.

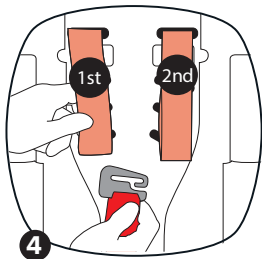

5. Tighten the harness (*see pg 38*).

## FOLDING CAR SEAT

1. Unbuckle harness and take out the red carry strap from behind the cover.
2. Unfasten both fabric panels and open fully.
3. Adjust both expandable side to their inward position.
4. Press down on silver harness release button to loosen harness straps, pads and chest clip.

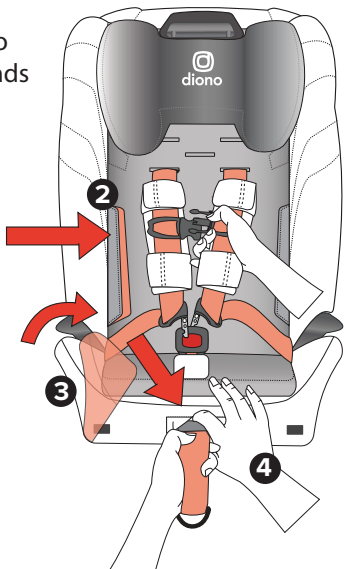
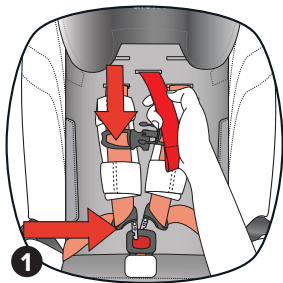

## FOLDING CAR SEAT

5. Place car seat on its back, pull on the red release levers while pushing the car seat forward in on itself.
6. Fasten red carry strap on the first metal bar on the bottom of the seat.

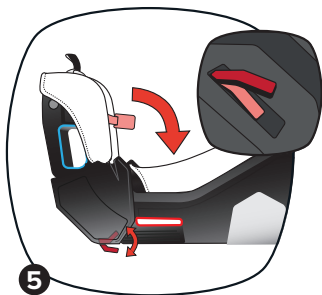

**IMPORTANT:** Make sure car seat is correctly secured by carry strap. Injury could occur if improperly secured.

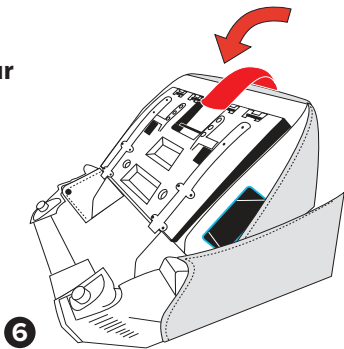

## SEAT COVER REMOVAL

**HINT:** Before removal have your phone handy and take photos of the process for future reference.

1. Remove harness straps from the harness hook on back of seat. Pull harness straps out through front of cover.
2. Remove headrest cover by pulling on tabs located on at the center of the headrest along the top and bottom. Remove fabric from channel along top and sides. Remove headrest cover.
3. Push headrest down to lowest position.
4. Locate and unfasten buttons under flap located under headrest.

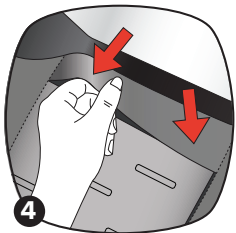
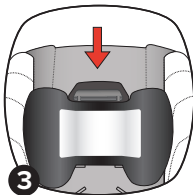
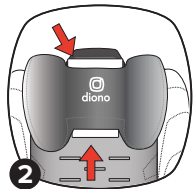
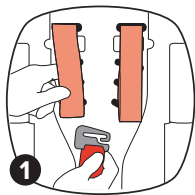



## SEAT COVER REMOVAL

5. Gently pull up on flap of cover to detach plastic fasteners from seat shell.
6. Unhook loops from seat shell. Pull headrest up to highest point and gently pull fasteners away from seat shell. Remove cover behind headrest.

Continued on the next page

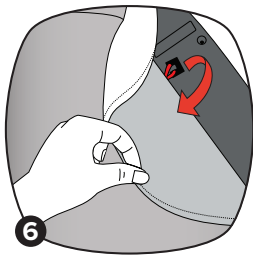
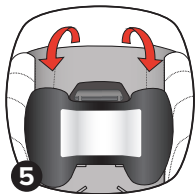

## SEAT COVER REMOVAL

8. To remove elastic strap from the hook on left and right sides of seat, pull elastic strap down with your fingers and with the other hand push the elastic over the plastic hook with a flat head screwdriver.
9. Gently pull the car seat fabric out of the plastic channel around the shell of the car seat.

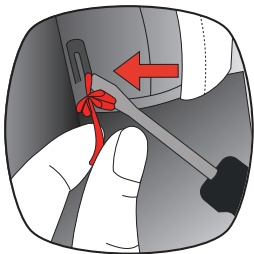
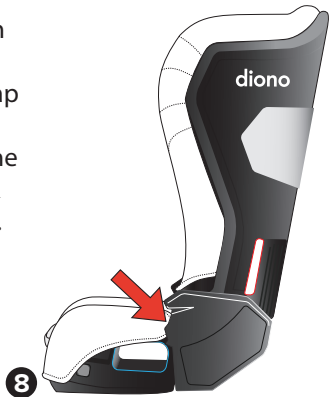

## SEAT COVER REMOVAL

10. Remove four plastic tabs from slots located on the sides of the bottom front of seat.
11. Remove buckle from memory foam cushion and seat cover bottom and pull seat cover free from seat shell.

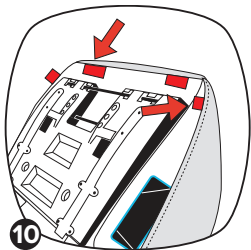

***To install cover repeat steps backward starting at step 11.***

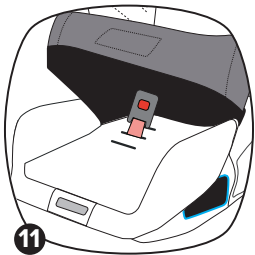

## CARE & MAINTENANCE

**CLEANING FABRICS:** Seat cover, infant support, center buckle pad and harness pads.

**REMOVE** memory foam insert from seat pad prior to washing. **DO NOT** wash memory foam.

**REMOVE** infant support wedge from infant support cushion before washing. **REMOVE** newborn protection wedge from newborn protection insert before washing. **DO NOT** wash support wedges.

Machine or hand wash fabrics in cold water on gentle cycle with mild detergent. Dry flat and away from direct sunlight before re-use or storage. **DO NOT** bleach, iron or dry clean.



**CLEANING HARNESS AND BUCKLE STRAPS:** Clean with damp cloth only. Wet cloth with warm water and mild soap. Wring cloth thoroughly and spot clean. Allow to dry completely before use. **DO NOT** use solvents, bleach or abrasive cleaners. **DO NOT** soak or submerge the harness webbing.



## CARE & MAINTENANCE

**CLEANING PLASTICS:** Spot clean using a damp cloth and warm water with mild detergent. Towel dry completely before re-use or storage. **DO NOT bleach.**



**CLEANING CENTER BUCKLE:** Remove center buckle from car seat. Gently rinse **ONLY** the buckle mechanism in mildly hot water, or soak overnight. **DO NOT** get the buckle strap wet. Towel dry center buckle. Make sure buckle is working correctly before reconnecting center strap to car seat. **DO NOT use detergents or lubricants.**

# WARRANTY

As a part of this Diono Warranty Policy (Policy), Diono, L.L.C. dba Diono, a Washington limited liability company (Diono U.S.A.), and its foreign-related companies, Diono ULC, a Canadian unlimited liability company (Diono Canada), Diono Ltd. a United Kingdom limited company (Diono U.K.), and Diono GmbH, a German company with limited liability (Diono E.U.) (Diono U.S.A., Diono Canada, Diono U.K., and Diono E.U. shall be collectively referred to herein as Diono), warrants its products, namely its car seats, strollers, baby carriers, and accessories thereto (collectively, the Products) to their non-merchant original retail Product purchasers (collectively, the Purchasers) as follows:

## 1. REGISTRATION

To qualify for the warranties detailed in this Policy, Diono instructs all Purchasers to complete the online Product Registration form and mail the owner registration card included in the Product Purchase to Diono within (30) days of purchase. Failing to take such actions may prevent a Purchaser from qualify for the warranties detailed in this Policy. For more information about Product registration, Purchasers are recommended to refer to their Product's Product Manual, the Diono Instruction Manual, and/or contact Diono as provided in Section 9 of this Policy. Such registration requirements detailed in this subsection of the Policy do not apply to warranties provided by Diono E.U. as detailed in Section 2.4 below.

## 2. GENERAL WARRANTY PERIOD

**2.1 General U.S. Warranty Period.** Diono U.S.A. warrants to Purchasers that its Products will be free from defects in material and workmanship for one (1) year from the date of original purchase (the U.S. Warranty Period). During the U.S. Warranty Period, Diono U.S.A. will, at its option, repair or replace a Product if it is found by Diono U.S.A. to be defective in material or workmanship.

**2.2 General Canadian Warranty Period.** Diono Canada warrants to Purchasers that its Products will be free from defects in material and workmanship for one (1) year from the date of original purchase (the Canadian Warranty Period). During the Canadian Warranty Period, Diono Canada will, at its option, repair or replace a Product if it is found by Diono Canada to be defective in material or workmanship.

**2.3 General U.K. Warranty Period.** Diono U.K. warrants to Purchasers that its Products will be free from defects in material and workmanship for one (1) year from the date of original purchase (the U.K. Warranty Period). During the U.K. Warranty Period, Diono U.K. will, at its option, repair or replace a Product if it is found by Diono U.K. to be defective in material or workmanship.

**2.4 General European Warranty Period.** Diono E.U. warrants to Purchaser that its Products are in conformity with their original contracts of sale (collectively, the Contracts), and notably will be free from defects in material and workmanship at the time the Products were delivered to Purchaser, for two (2) years from the date of original purchase (the European Warranty Period). The Products are presumed to be in conformity with the Contract if they are fit for the purposes for which products of the same type are normally used, or show the quality and performance which are normal in products of the same type and which Purchaser can reasonably expect, given the nature of the Products and taking into account any public statements on the specific characteristics of the goods made about them by Diono, particularly in advertising or on labelling. Purchaser must inform Diono E.U. of the Lack of Conformity within a period of two (2) months from the date on which Purchaser detected such lack of conformity discovery. There shall be deemed to not be a Lack of Conformity at the time the Contract was concluded when Purchaser was aware, or could not reasonably be unaware, of the Lack of Conformity. During the European Warranty Period, Diono E.U. will, at the Purchaser's option, repair or replace a Product free of charge, within a reasonable time and without any significant

# WARRANTY

inconvenience to the Purchaser, if it is found by Diono E.U. to be defective in material or workmanship respectively, unless this is impossible or disproportionately burdensome. When repair or replacement of a Product are impossible or disproportionately burdensome, the Purchaser may request a refund of the Product or a reduction of its price in proportion to the degree of non-conformity of the said Product, otherwise in accordance with the Diono Return Policy.

## 3. EXTENDED EXPRESS WARRANTIES

**3.1 Qualifications.** Diono warrants to Purchasers an extended warranty (Extended Warranty) for certain Products, namely (a) 2020 model year strollers and car seats (namely, Radian R and Q, Monterey, Cambria, Everett and Solana, and strollers (Flexa and Excurze)), and (b) Diono Canada car seats and strollers (collectively, Extended Warranty Products) that will be free from defects in material and workmanship for a period of two (2) years after the general warranty periods detailed in Section 2 of this Policy (the Extended Warranty Period) has expired, provided that: (i) such Extended Warranty Product(s) were purchased new from the Website; (ii) its Purchasers have fully registered their Extended Warranty Products on the Website within two (2) months of purchase; and (iii) An original receipt of purchase for such Extended Warranty Product(s) are provided to Diono for verification. This Extended Warranty applies only in the U.S.A., the U.K. and Germany. During the Extended Warranty Period, Diono will, at its option, repair or replace a qualifying Extended Warranty Product if it is found by Diono to be defective in material or workmanship.

**3.2 Extended Warranty Limitations.** It is expressly agreed that Diono's obligations and the Purchaser's remedies under the limited extended warranty contained herein are exclusive and are strictly limited to the repair or replacement of the Extended Warranty Product. This limited extended warranty is conditional upon strict compliance with the provisions of the Instruction Manual for the Extended Warranty Product(s) in question. In no event will Diono be liable to Purchaser for any damages, including incidental or consequential damages, arising out of the use or inability to use any Extended Warranty Product.

## 4. IMPLIED WARRANTIES

Any implied warranties applied to a Product, including without limitation implied warranties of merchantability and fitness for a particular purpose, shall be limited to the duration and terms of the express written warranties detailed in this Policy. Such warranties give Purchasers specific legal rights which vary from jurisdiction-to-jurisdiction. Some U.S. states and Canadian provinces do not allow limitations on how long an implied warranty lasts or the exclusion or limitation of incidental or consequential damages. As such, such implied warranty limitations may not apply. Notwithstanding, neither Diono, nor any retailer selling any Product, authorizes any person to create for it any other warranty, obligation, or liability in connection with any Product not otherwise detailed in this Policy.

## 5. WARRANTY LIMITATIONS

**5.1 Damage Limitations.** The warranties identified in this Policy do not cover: (a) any Product purchased from a non-authorized Diono retailer; (b) the effects of normal wear and tear on a Product; (c) damage arising from Product repairs or modifications carried out by a third party; (d) a Product's involvement in an accident; (e) dissatisfaction with a Product's fit, weight, functionality, color or style; (f) Product damage resulting from negligence, modification, improper installation, accident, transport damage, incorrect washing of covers, corrosion, rust, mold, insufficient maintenance, misuse or abuse; or (g) any Product defect that originated from material or design supplied by the Purchaser.

# WARRANTY

**5.2 Remedy Limitations.** It is expressly agreed that Diono's obligations and a Purchaser's remedies under the limited warranties provided in this Policy are exclusive and are strictly limited to the repair or replacement of a Product unless as otherwise detailed in Section 2 of this Policy. Such limited warranties are also conditional upon strict compliance with the provisions of the Instruction Manual for the Product(s) in question. In no event will Diono or any of their authorized manufacturers or retailers be liable to a Purchaser for any damages, including without limitation incidental or consequential damages, arising out of a Purchaser's use or inability to use any Product.

**5.3 Other Requirements and Limitations.** The warranties detailed in this Policy: (a) are non-transferable by Purchaser; (b) are only valid when supplied with proof of purchase from an authorized retailer or the Website; and (c) are valid only in the original country of the Product's purchase.

## 6. USE OF OUTSIDE PARTS AND ACCESSORIES

The use of covers, inserts, toys, accessories, or tightening devices produced by parties other than Diono or its authorized manufacturers (collectively, Outside Products) in any Product is not approved by Diono. The use of any Outside Product in conjunction with a Product could cause the Product to fail U.S., Canadian, U.K., and/or European safety standards. As a result, use of any Outside Product with a Product automatically voids any warranties granted under this Policy.

## 7. RESERVED RIGHTS

Diono reserves the right to: (a) discontinue any Product; (b) change a Product's parts, fabrics, or design; (c) substitute a Product with a comparable model or Product; or (d) apply a divergent manufacturer's guarantee for a Product in any specific geographical region.

## 8. SHIPPING CHARGES

Shipping charges for the replacement of any Product pursuant to a warranty granted under this Policy will be Purchaser's sole responsibility. Diono will not be responsible for any delays or damage caused by the shipment of a replacement Product. More information about Diono's shipping policies can be found in the Diono Shipping Policy.

## 9. QUESTIONS

Should any Purchaser have issues concerning a warranty or this Policy, Diono recommends contacting Diono Customer Service at 855-463-4666 (8:00 am to 3:00 pm PST) or support@diono.zendesk.com for help or assistance.



# NOTES

**diono**<sup>®</sup>  
#MadeOfSeattle



© 2023 Diono LLC | 14810 Puyallup Street E | Suite 200  
Sumner WA 98390 | United States  
United States: [diono.com](http://diono.com) | 1-855-463-4666  
Canada: [diono.ca](http://diono.ca) | 1-866-954-9786

Made in China | All rights reserved  
revised/revisado 20230113